



LVL G by Stora Enso

Structural design manual

Stora Enso
Kanavaranta 1
P.O. Box 309
FI-00101 Helsinki, Finland
Tel: + 358 20 46 131
www.storaenso.com



Table of Contents

1. Product description	5
1.1 Basic product information	5
1.2 LVL G dimensions	6
1.3 Cross sections	7
2. Material	9
2.1 Stiffness and strength properties	9
2.2 General	11
2.3 Intended use	11
2.4 Mechanical resistance and stiffness	11
3. Creep and duration of load	11
3.1 Partial factor for the material	11
3.2 Partial safety factors for loads and load combinations	11
3.3 Factors accounting for the load duration and moisture content	12
3.4 Dimensional stability	13
3.5 Durability	13
3.6 Size effect parameters	14
4. Design principles	14
4.1 Ultimate limit states principle	14
4.2 Design values	14
4.3 Member axis of LVL G	15
5. Ultimate Limit States	16
5.1 Bending parallel to the grain	16
5.1.1 Flatwise bending strength	16
5.1.2 Edgewise bending strength	18
5.1.3 Bending stress	19
5.2 Bending perpendicular to the grain	20
5.2.1 Flatwise bending strength	20
5.3 Tension parallel to the grain	21
5.3.1 Tensile strength	21
5.3.2 Tensile stress and verification	21
5.4 Tension perpendicular to the grain	22
5.4.1 Edgewise tensile strength	22
5.4.2 Flatwise tensile strength	22
5.4.3 Tensile stress and verification	23
5.5 Compression parallel to the grain	23
5.5.1 Compressive strength	23
5.5.2 Compressive stress and verification	24
5.6 Compression perpendicular to the grain	25
5.6.1 Edgewise compressive strength	25
5.6.2 Flatwise compressive strength	25
5.6.3 Compressive stress and verification of bearing pressure strength	26
5.6.4 Effective spreading length of a supported and loaded beam member	28
5.6.5 Effective spreading length of a point discretely supported and loaded member	32
5.7 Bending stress at an angle α to the grain	34
5.8 Compressive and tensile stress at an angle α to the grain	34
5.8.1 Compression strength at an angle to the grain	34
5.8.2 Verification of compressive stress at an angle α to the grain	35
5.8.3 Tension at an angle to the grain	35
5.9 Stability of LVL G members	36
5.9.1 Members subjected to combined bending and axial compression or tension	36



DESIGN MANUAL

Dec-20

5.9.2	Oblique bending.....	36
5.9.3	Buckling of LVL G columns subjected to either compression or combined compression and bending	37
5.9.4	Lateral torsional buckling of LVL G beams subjected to either bending or combined bending and compression.....	40
5.10	Shear parallel to the grain.....	42
5.10.1	Flatwise shear strength.....	42
5.10.2	Edgewise shear strength	43
5.10.3	Shear stress and verification	44
5.11	Shear perpendicular to the grain	45
5.11.1	Flatwise shear strength : Rolling shear.....	45
5.11.2	Shear stress and verification	45
6.	Tapered beams	46
6.1	Single tapered beams	46
6.2	Double tapered beams.....	49
6.2.1	Climate action on double-tapered beams	51
7.	Notched beams	52
8.	Holes in edgewise beams	53
8.1	Geometric boundary conditions	53
8.2	Size and location of the holes	55
8.3	Verification of the tension perpendicular to grain (approach of Ardalany).....	56
8.3.1	due to pure shear	56
8.3.2	due to pure bending	57
8.3.3	Beam subjected to combined shear and bending moment (Splitting)	58
8.3.4	Fracture energy rate G_I, f in mode I (opening)	58
8.4	Verification of shear stresses for circular and rectangular holes in beams	58
8.5	Verification of longitudinal stresses- Bending.....	59
9.	Connections with fasteners in LVL G's edge and wide face	61
9.1	Fastener angles, spacings, edge and end distances	62
9.1.1	Laterally loaded fasteners in wide and edge faces.....	62
9.1.2	Axially loaded fasteners	62
9.1.3	Minimum spacings, end distances and edge distances	63
9.2	Nailed connections.....	66
9.2.1	Laterally loaded nails	66
9.2.2	Axially loaded nails	67
9.3	Bolted and doweled connections	67
9.3.1	Laterally loaded bolts or dowels	67
9.4	Screwed connections.....	68
9.4.1	Laterally loaded screws	68
9.4.2	Axially loaded screws.....	70
9.4.3	Tension screwed connection	71
10.	Serviceability Limit States	73
10.1	Deflection	73
10.2	Vibration.....	75
11.	Safety in case of fire.....	78
11.1	Reaction to fire.....	79
11.2	Resistance to fire of LVL G based on calculations according to EN 1995-1-2:2011 (Eurocode 5)	79
11.3	Verification method for actions in the fire situation according to EN 1995-1-2:201180	
11.4	Verification method for mechanical resistance in the fire situation according to EN 1995-1-2:2011	81



storaenso

DESIGN MANUAL

Dec-20

11.5	Charring rates of LVL G by Stora Enso	81
11.5.1	Design value of charring rates for LVL G on surfaces which are unprotected throughout the duration of the fire	82
11.5.2	Design value of charring rates for LVL G on surfaces which are initially protected from exposure to fire by gypsum plasterboard	84
11.5.3	Start of charring on initially protected components	86
11.5.4	Failure time of fire protective claddings	87
11.6	Determining the load-bearing capacity (R) of LVL G elements according to EN 1995-1-2:2011	88
11.6.1	Reduced cross-section method	89
11.7	Structural analysis in fire	90
12.	Seismic evaluation	91
13.	Installation	91
13.1	Protection against temporary moisture exposure of structural LVL G	91
13.2	Resistance against UV radiation	91
13.3	Recommendations on packaging, transport and storage maintenance, replacement and repair	91
14.	Annexes	92
14.1	Multi axial stresses	93
14.2	Beams with tapered edge	96
	References	97



Posts & Beams

This design manual focuses on LVL G post and beam elements.
A separate design manual for LVL G panel elements will be available for design guidance.

1. Product description

1.1 Basic product information

Stora Enso Glued laminated LVL (LVL G) is covered by the ETA 20/0291 [1]. It is comprised of structural Laminated Veneer Lumber (LVL) components bonded together with a PUR adhesive at their flatwise surfaces. The adhesive used is approved for gluing of load-bearing structures and suitable for gluing of Stora Enso LVL. The adhesive used in manufacturing of Stora Enso LVL G is of type I (full exposure to the weather) as defined in EN 15425. The LVL laminations are manufactured according to EN 14374 without finger or other end joints and are calibrated to standard thicknesses. The veneers of the LVL are peeled from spruce softwood.

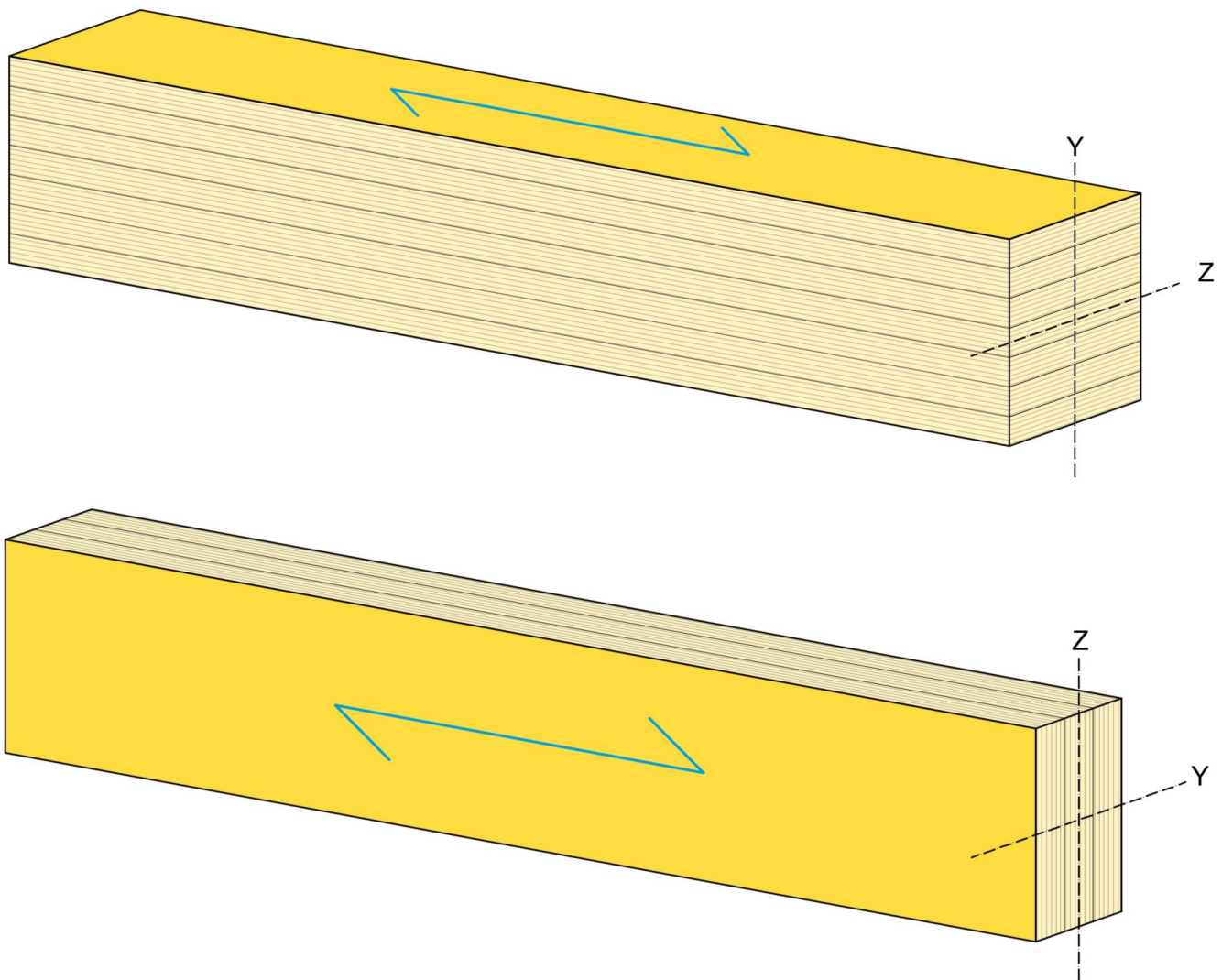

Figure 1: LVL G section types

There are several types of products that all are manufactured according to the same principles.

1.2 LVL G dimensions

Guidelines for LVL G panel dimensions are presented in Table 1 .

The maximum size of the LVL G master panels are:

Type L: 600 mm x 2 500 mm x 19 900 mm (beams, columns and slab elements)

Stora Enso LVL G Flatwise or Edgewise sections:

Beams with rectangular cross section. The beams are glued of LVL S grade or X-grade and can be used edgewise or flatwise. Typical cross sections are shown in Figure 2. The thickness of laminations can be from 24 to 69 mm while the width of the laminations may be from 100 to 2500 mm.

Calibrated laminations 30, 36, 42, 48 and 60 mm are used for the standard manufactured product and standard width are also available from 200mm to 600mm as described in Table 1: Standard dimensions of Stora Enso LVL G. When used in edgewise bending, the components may have uniform height, or they may be single or double tapered. Openings are allowed to be taken for Type B in accordance with the design instructions in chapter 8.

Width h $\leq 2\,500\text{mm}$
 Thickness b $50 - 600\text{ mm}$
 Length L $\leq 19\,900\text{ mm}$

Flatwise section

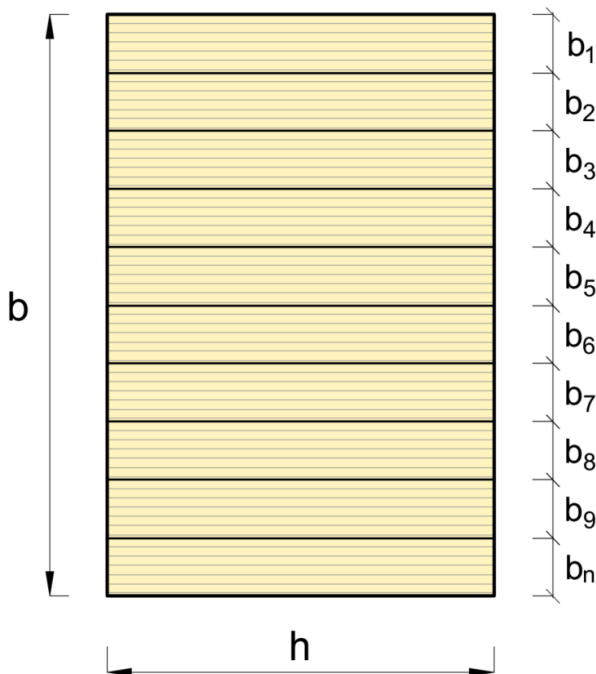

Edgewise section

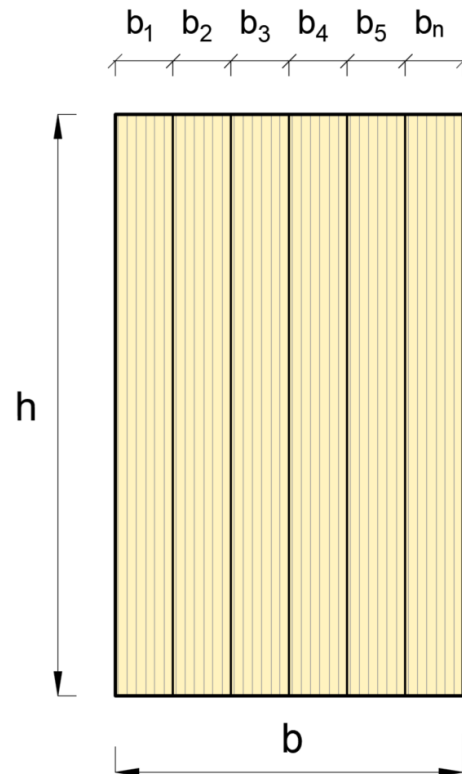

Figure 2: LVL G flatwise and edgewise cross sections

1.3 Cross sections

Table 1: Standard dimensions of Stora Enso LVL G

b [mm]	Calibrated lamella thicknesses [mm]										Height / Width [mm]								
	b ₁	b ₂	b ₃	b ₄	b ₅	b ₆	b ₇	b ₈	b ₉	b ₁₀	h								
72	72										200	240	260	300	350	400	450	500	600
84	42	42									200	240	260	300	350	400	450	500	600
90	30	30	30								200	240	260	300	350	400	450	500	600
96	48	48									200	240	260	300	350	400	450	500	600
108	36	36	36								200	240	260	300	350	400	450	500	600
120	60	60									200	240	260	300	350	400	450	500	600
126	42	42	42								200	240	260	300	350	400	450	500	600
144	48	48	48								200	240	260	300	350	400	450	500	600
150	30	30	30	30	30						200	240	260	300	350	400	450	500	600
168	42	42	42	42							200	240	260	300	350	400	450	500	600
180	60	60	60								200	240	260	300	350	400	450	500	600
192	48	48	48	48							200	240	260	300	350	400	450	500	600
210	42	42	42	42	42						200	240	260	300	350	400	450	500	600
216	36	36	36	36	36	36					200	240	260	300	350	400	450	500	600
240	60	60	60	60							200	240	260	300	350	400	450	500	600
252	42	42	42	42	42	42					200	240	260	300	350	400	450	500	600
270	30	30	30	30	30	30	30	30	30	30	200	240	260	300	350	400	450	500	600
288	48	48	48	48	48	48					200	240	260	300	350	400	450	500	600
294	42	42	42	42	42	42	42	42			200	240	260	300	350	400	450	500	600
300	60	60	60	60	60						200	240	260	300	350	400	450	500	600
324	36	36	36	36	36	36	36	36	36	36	200	240	260	300	350	400	450	500	600
336	48	48	48	48	48	48	48	48			200	240	260	300	350	400	450	500	600
360	60	60	60	60	60	60					200	240	260	300	350	400	450	500	600
378	42	42	42	42	42	42	42	42	42	42	200	240	260	300	350	400	450	500	600
384	48	48	48	48	48	48	48	48	48		200	240	260	300	350	400	450	500	600
420	60	60	60	60	60	60	60	60			200	240	260	300	350	400	450	500	600
432	48	48	48	48	48	48	48	48	48	48	200	240	260	300	350	400	450	500	600
480	60	60	60	60	60	60	60	60	60		200	240	260	300	350	400	450	500	600
540	60	60	60	60	60	60	60	60	60		200	240	260	300	350	400	450	500	600
600	60	60	60	60	60	60	60	60	60	60	200	240	260	300	350	400	450	500	600

- Intended use: beam and column elements, edgewise and flatwise
- Material: LVL-S and LVL-X
- Multiple glued with lay-up Type L (with all layers in longitudinal direction)
 - Optimal lamella thicknesses 33/39/45/51/63mm
- Master panel sizes (see Figure 3)
 - Thickness 84mm to 600mm
 - Width: 2 500 mm (2 520mm on request) (beams, columns and slab elements): Type L
 - Width: 2 500 mm (wall elements): Type C →(covered in another design manual dedicated to LVL G panels)
 - Length from 6m up to 19.9 m



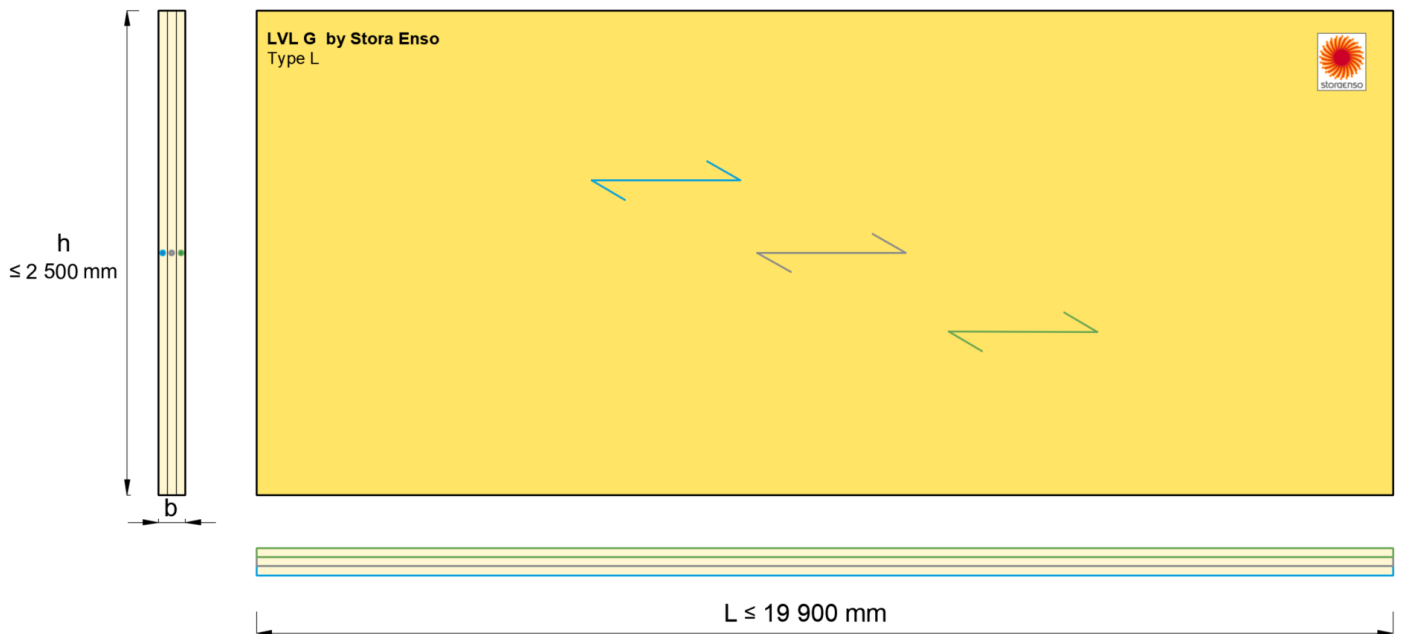

Figure 3: Example of LVL G masterpanel type L - LVL layers. Colours: first outer layer (blue), inner layer (gray), second outer layer (green).

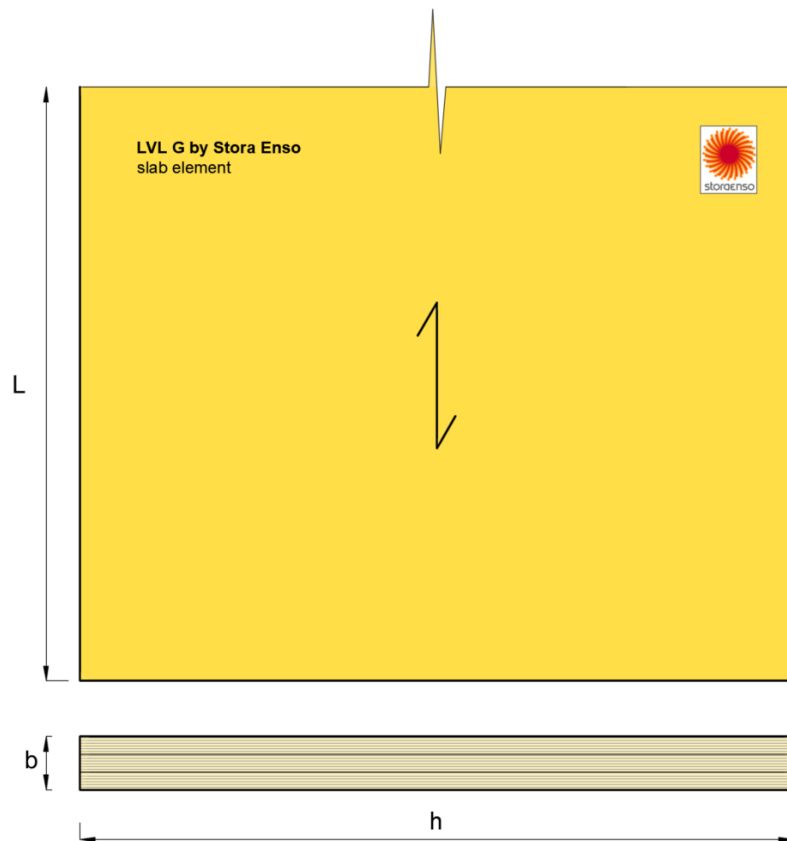

Figure 4: Slab cross section of LVL G by Stora Enso type L.

2. Material

2.1 Stiffness and strength properties

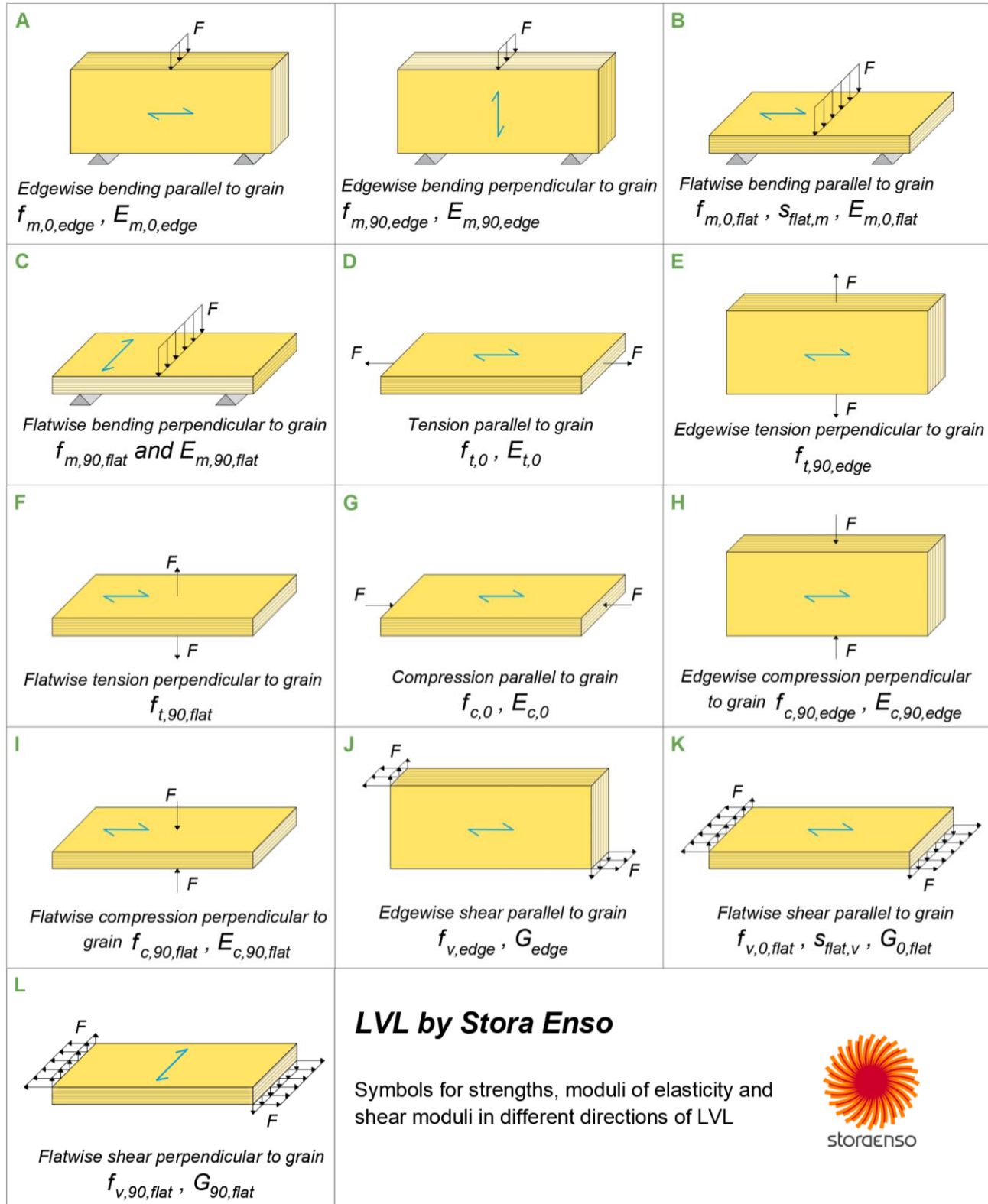

Figure 5: Definition of the strength and stiffness orientations

DESIGN MANUAL

Dec-20

Table 2: Characteristic and mean values of Stora Enso LVL G-S and LVL G-X grade to be used in design.

Strength properties	Direction	Designation	Unit	Figure	LVL G-S	LVL G-X
					LVL 24-69mm lamination	
Bending strength	Edgewise, parallel to the grain	$f_{m,0,edge,k}$	N/mm ²	A	44,0	32,0
	Flatwise, parallel to the grain	$f_{m,0,flat,k}$	N/mm ²	B	45,0	31,0
	Flatwise, perpendicular to the grain	$f_{m,90,flat,k}$	N/mm ²	C	-	8,0
Size effect parameter	Size effect edgewise	$S_{m,edge}$	-	A	0,12	0,12
	Size effect flatwise bending	$S_{m,flat}$	-	B	0,11	0,13
	Size effect flatwise shear	$S_{v,flat}$	-	K	-	0,13
Tensile strength	Parallel to the grain	$f_{t,0,k}$	N/mm ²	D	35,0	26,0
	Perpendicular to the grain, flatwise	$f_{t,90,flat,k}$	N/mm ²	F	0,20	-
	Perpendicular to the grain, edgewise	$f_{t,90,edge,k}^{(1)}$	N/mm ²	E	0,8	6,0
Compressive strength	Parallel to the grain- Service class 1	$f_{c,0,k}$	N/mm ²	G	35,0	26,0
	Parallel to the grain- Service class 2				29,0	21,0
	Perpendicular to the grain, edgewise	$f_{c,90,edge,k}$	N/mm ²	H	6,0	9,0
	Perpendicular to the grain, flatwise	$f_{c,90,flat,k}$	N/mm ²	I	2,2	2,2
Shear strength	Edgewise, parallel to the grain	$f_{v,0/90,edge,k}^{(2)}$	N/mm ²	J	4,2	4,5
	Flatwise, parallel to the grain	$f_{v,0,flat,k}$	N/mm ²	K	2,3	1,3
	Flatwise, perpendicular to the grain	$f_{v,90,flat,k}$	N/mm ²	L	-	0,6
Modulus of elasticity	Mean, parallel to the grain, edgewise	$E_{0,edge,mean}$	N/mm ²	A D G	13 800	10 500
	Mean, parallel to the grain, flatwise	$E_{0,flat,mean}$	N/mm ²	B	12 400	10 100
	Char, parallel to the grain, edgewise	$E_{0,edge,k}$	N/mm ²	A D G	11 600	8 800
	Char, parallel to the grain, flatwise	$E_{0,flat,k}$	N/mm ²	B	11 200	8 800
	Char, Bending perpendicular to the grain, flatwise	$E_{90,flat,mean}$	N/mm ²	C	-	2 000
	Mean, Bending perpendicular to the grain	$E_{90,flat,k}$	N/mm ²	C	-	1 700
	Mean, perpendicular to the grain, edgewise	$E_{90,edge,mean}$	N/mm ²	H	-	2 400
	Char, perpendicular to the grain, edgewise	$E_{90,edge,k}$	N/mm ²	H	-	2 000
Shear modulus	Mean, edgewise, parallel to grain	$G_{0/90,edge,mean}$	N/mm ²	J	600	600
	Char, edgewise, parallel to grain	$G_{0/90,edge,k}$	N/mm ²	J	400	400
	Char, flatwise, parallel to grain	$G_{0,flat,k}$	N/mm ²	K	380	100
	Mean, flat, parallel to grain	$G_{0,flat,mean}$	N/mm ²	K	440	120
	Mean, flat, perpendicular to grain	$G_{90,flat,mean}$	N/mm ²	L	-	22
	Char, flat, perpendicular to grain	$G_{90,flat,k}$	N/mm ²	L	-	16
Density	Mean density	ρ_{mean}	kg/m ³	-	510	510
	Char density	ρ_k	kg/m ³	-	480	480

(1) When edgewise bending property in 90° direction is not defined, $f_{t,90,edge,k}$ value should be used as $f_{m,90,edge,k}$.

(2) $f_{v,0,edge,k} = f_{v,90,edge,k}$ (Edgewise shear strength $f_{v,0,edge,k}$ is valid for 90° direction too. It is unnecessary practice to have "0" in the index for the edgewise value. Only in flatwise shear, the direction 0° or 90° matters.)



storaenso

These values are based on declared values given in reports:

- Varkaus 2020-04-08 DoP LVL by Stora Enso, S grade, thickness 24-75mm
- Varkaus 2017.02.16 DoP LVL by Stora Enso, X grade, thicknesses 24-69mm
- VTT analysis reports VTT-S-05550-17 [2] and VTT-S-05710-17 [3]
- Report no EUFI29-19002201-T1 [4] and Report no EUFI29-19002201-T2 [5]

2.2 General

The design of LVL and LVL G members according to Eurocode 5 requires strength values of the primary LVL as well as size effect parameters "s". For LVL loaded edgewise in bending and parallel to grain in tension, EN1995-1-1 gives a size effect parameter $s = 0,12$ and a reference depth $h_{ref} = 300$ mm for edgewise bending and a reference length $L_{ref} = 3000$ mm for tension, respectively.

For flatwise bending, compression parallel or perpendicular to grain, tension perpendicular to grain or shear no size effect parameters are given in Eurocode 5 for primary LVL. According to draft EAD DP 130337-00-0304 [6] size effect parameters are required for bending strength (edgewise and flatwise), tension strength parallel to grain, and shear strength (flatwise). While for edgewise bending and tensile strength parallel to grain the size effect parameter of LVL is directly applicable to LVL G, size effect parameters for flatwise bending and shear strength (flatwise and edgewise) need to be determined.

2.3 Intended use

Stora Enso LVL G is intended to be used as a non-structural or structural element for load-bearing applications in building and civil engineering structures. With regard to moisture behaviour of the product, the use is limited to service classes 1 and 2 as defined in EN 1995-1-1.

Composite action of the parts is achieved by adhesive bonded joints. Mechanical connectors are not used to achieve the composite action of the parts, but nails or screws between the parts may be used in order to achieve the pressure needed for a proper glue bond. In Stora Enso case, pressing is used. Therefore, cross sections of Stora Enso LVL G are allowed to be handled as monolithic.

Design shall be carried out according to EN 1995-1-1 and EN 1995-1-2. Strength and stiffness values of Stora Enso LVL G given in Table 2 shall be used in the design.

2.4 Mechanical resistance and stiffness

The LVL G by Stora Enso products are manufactured according to an individual design or delivered as standard products. In case of individual production, the design can be made on a case by case basis by the manufacturer or by a third party according to the design instructions of the manufacturer. Strength values of Stora Enso LVL G to be used in design together with information of the dimensions of the components are given in Table 1 and Table 2. The design instructions of the manufacturer have been reviewed by Eurofins Expert Services . In case of updating, the new versions shall be approved by Eurofins Expert Services Oy.

3. Creep and duration of load

3.1 Partial factor for the material

For LVL partial safety factor is according to EN 1995-1-1:

$$\gamma_M = 1.2$$

Exception: if national annex of EN 1995-1-1 is overruling this value.

3.2 Partial safety factors for loads and load combinations

The design value E_d for the effects of actions shall be calculated using EN 1990 and its national annexes. Partial factors for loads, load combinations and for different consequence classes are taken from the appropriate national annex.



3.3 Factors accounting for the load duration and moisture content

The moisture content and the load duration shall be taken according to the appropriate national annex. The modification factors for strength k_{mod} and deformation k_{def} shall be according to EN1995-1-1 and the applicable National annex. A recommendation is given in the tables below.

In Table 4, values for k_{mod} and in Table 5, values for k_{def} can be found.

Table 3: Load-duration class and load types.

Load-duration class	Action time of the load	Load
Permanent	More than 6 months	Self-weight, imposed load Category E
Medium-term	10 minutes - 6 months	Imposed floor load, snow
Short term	Less than 1 week	Snow
Instantaneous	Below 10 minutes	Wind, accidental load

Effects of duration of load are taken into account according to EN 1995-1-1. The following k_{mod} values apply in service classes 1 and 2 for both Stora Enso LVL S grade and Stora Enso LVL X-grade component parts:

Table 4: Strength modification factor k_{mod} .

Service class	Load-duration class			
	Permanent action	Medium term action	Short term action	Instantaneous action
1	0.60	0.80	0.90	1.10
2	0.60	0.80	0.90	1.10

In calculation of the final deflection, creep is considered according to EN 1995-1-1. The following deformation factors k_{def} shall be used:

Table 5: Values of the deformation factor k_{def} .

	Service class	
	1	2
LVL-X edgewise		
LVL-S edgewise	0.60	0.80
LVL-S flatwise		
LVL-X flatwise	0.80	1.00

The values in the second row are used only for flatwise bending and flatwise shear deformation of LVL X. Otherwise the k_{def} of LVL-X has the same values as for LVL S.

The service classes are defined in the standard EN 1995-1-1.

Service class 1 means that the structure is in warmed in-doors conditions where the moisture content corresponds mainly to a temperature of 20°C and the relative humidity of air exceeds 65% only for a few weeks per year.

Service class 2 is characterised by a moisture content in the materials corresponding to a temperature of 20°C and the relative humidity of the surrounding air only exceeding 85 % for a few weeks per year.

Deformation factor k_{def} is a factor to evaluate creep deformation.



3.4 Dimensional stability

Tolerances of dimensions for Stora Enso LVL G and swelling and shrinkage values for Stora Enso LVL G are given in Table 6 and Table 7.

The swelling and shrinkage behavior due to change in moisture content of LVL lamination relates to the swelling and shrinkage behavior of the base material.

When manufactured, the moisture content of the components is below the equilibrium value in use conditions. Due to changing temperature and relative humidity of the surrounding air the moisture content of Stora Enso LVL G will continuously change.

The swelling and shrinkage values for Stora Enso LVL products in % per % change of moisture content are given in Table 6. They shall be used to determine the dimensional changes of Stora Enso LVL G.

Table 6: Swelling and shrinkage coefficients in different direction of Stora Enso LVL G in % per % change of moisture content.

Type of timber and species	Swelling and shrinkage in percent per percent change of moisture content [7]		
	In the direction of the thickness	In the direction of the length	In the direction of the width
LVL-S (spruce)	0,30	0,01	0,31
LVL-X (spruce)	0,44	0,01	0,033

Table 7: Tolerances of Stora Enso LVL G.

Dimension	Size [mm]	Tolerance [mm] or [%]
Overall depth h	< 400	± 2 mm
	≥ 400	± 0,5 %
Overall width b	All	± 3 mm
Overall length L	All	± 5 mm

Cross sections of Stora Enso LVL G are in general symmetrical or almost symmetrical thus minimizing any effects of moisture changes to overall shape of the cross section. No distortion of the cross sections is expected in normal use conditions.

Effect of varying moisture content to the nominal dimensions is normally negligible and within the tolerances given in Table 7.

3.5 Durability

The adhesive of type I can also be used in service class 3 but the untreated Stora Enso LVL flange and web materials do not withstand attacks from fungi. Thus, Stora Enso LVL G can be used in service classes 1 and 2 according to EN 1995-1-1, and hazard classes 1 and 2 as specified in EN 335. The product may be exposed to the weather for a short time during installation.

Risk of mold growth can occur in service class 2 without surface treatment.

Durability may be reduced by attack from insects such as long horn beetle, dry wood termites and anobium in regions where these may be found.



3.6 Size effect parameters

The effect of the size of member shall be taken into consideration in the design according to [8] and [6]. For member in edgewise bending the characteristic value for $f_{m,0,edge,k}$ shall be multiplied by the factor

$$k_h = \min \left\{ \left(\frac{300}{h} \right)^{s_{edge}}, 1.2 \right\} \quad \text{Eq 1}$$

s_{edge} size effect parameter in edgewise direction (defined in EN 14374) to be found in Table 2.
 h height of the member [mm]

For member in flatwise bending the characteristic value for $f_{m,0,flat,k}$ shall be multiplied by the factor

$$k_{h,m,flat,LVL\ G-S} = \left(\frac{90}{h} \right)^{s_{m,flat,LVL\ G-S}} \quad \text{Eq 2}$$

$$k_{h,m,flat,LVL\ G-X} = \left(\frac{90}{h} \right)^{s_{m,flat,LVL\ G-X}} \quad \text{Eq 3}$$

For member in flatwise shear the characteristic value for $f_{v,0,flat,k}$ shall be multiplied by the factor

$$k_{h,v,flat,LVL\ G-X} = \left(\frac{90}{h} \right)^{s_{v,flat,LVL\ G-X}} \quad \text{Eq 4}$$

$s_{m,flat}$ size effect parameter in flatwise bending direction (defined in [6] and [5]) to be found in Table 2.
 $s_{v,flat}$ size effect parameter in flatwise shear direction (defined in [6] and [5]) to be found in Table 2.
 h depth in flatwise direction of the member [mm]

Size effect factor is not used for the design of LVL G-S in shear.

For member in tension the characteristic value for $f_{t,0,k}$ shall be multiplied by the factor

$$k_l = \min \left\{ \left(\frac{3000}{l} \right)^{s/2}, 1.1 \right\} \quad \text{Eq 5}$$

s size effect parameter used in edgewise direction s_{edge} to be found in Table 2.
 l length of the member [mm]

4. Design principles

4.1 Ultimate limit states principle

Requirement:

$$E_d \leq R_d \quad \text{Eq 6}$$

where

E_d is the design value of the effect of actions

R_d is the design value of the corresponding resistance

4.2 Design values

The design values are calculated as

$$X_d = k_{mod} \cdot \frac{X_k}{\gamma_M} \quad \text{Eq 7}$$



X_d design strength
 X_k characteristic strength
 k_{mod} modification factor

$$E_d \leq R_d \quad \text{Eq 8}$$

4.3 Member axis of LVL G

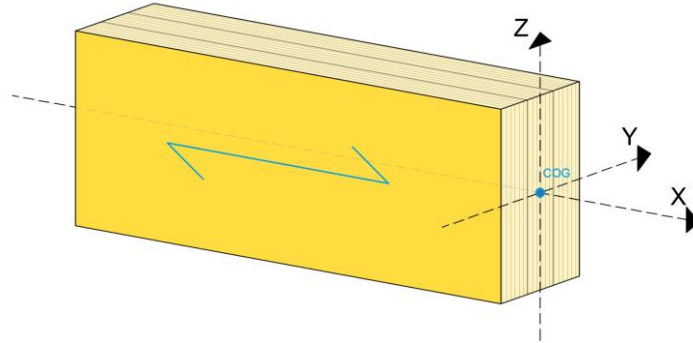
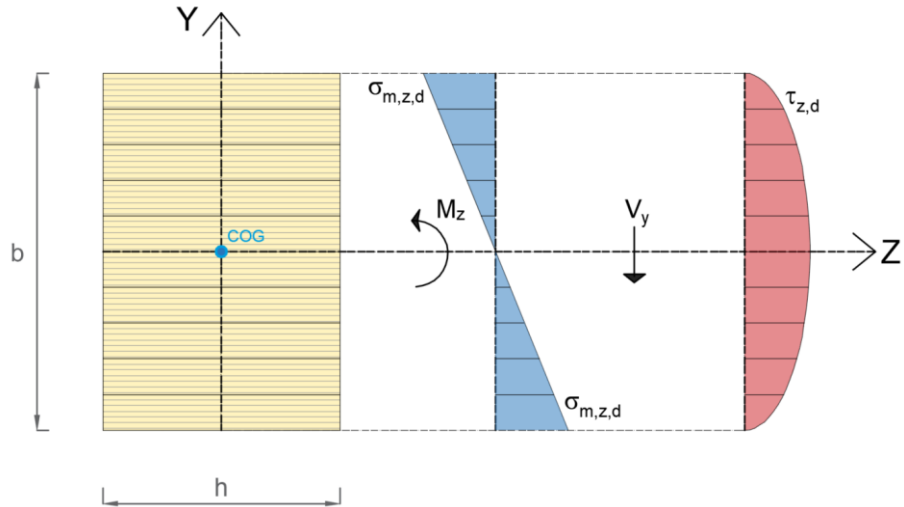

Figure 6: Principal axis of LVL G section

Flatwise



Edgewise

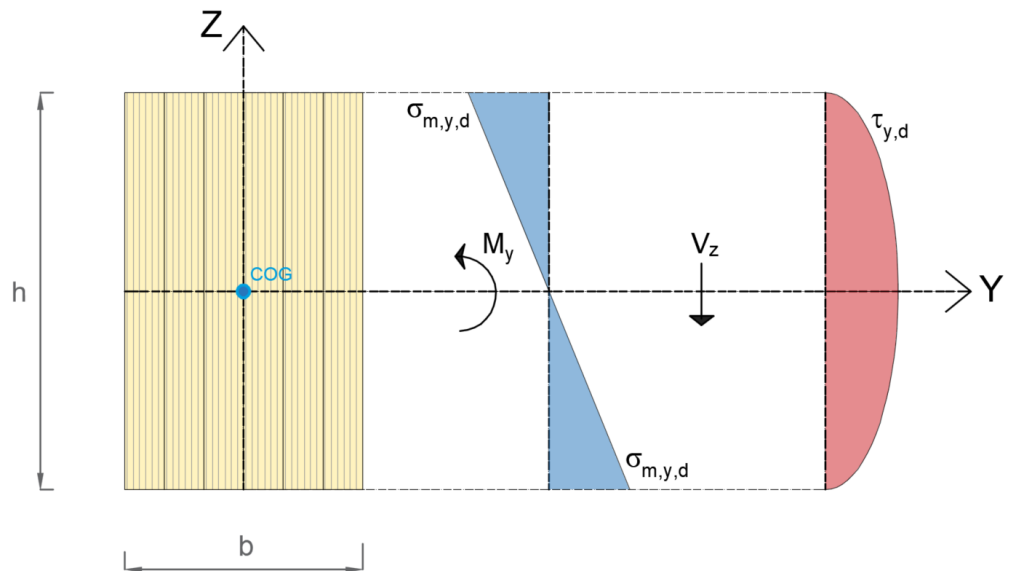

Figure 7: Principal axis of LVL G depending on the orientation type and bending and shear stress associated

5. Ultimate Limit States

The mechanical properties presented in this chapter can also be found in the ETA 20/0291 [1].

5.1 Bending parallel to the grain

5.1.1 Flatwise bending strength

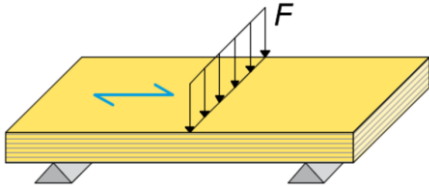

From the characteristic values determined for different tested cross sections, the characteristic flatwise bending strength for different LVL G thicknesses may be determined using the size effect as:

$$f_{m,flatwise,k}(b) = f_{m,flatwise,k}(b_0) \cdot \left(\frac{b_0}{b}\right)^{S_{m,flat}} \quad \text{Eq 9}$$

where

$f_{m,flatwise,k}$	Characteristic flatwise bending strength of LVL G according to [5]
b	Depth of the LVL G member in flatwise direction
b_0	Reference depth of the LVL G in flatwise direction
S_{flat}	Size effect factor considering the dependence on the depth b <u>in flatwise direction</u> according to [5]

as written in Table 2:

$$S_{m,flat,LVL\ G-S} = 0,11$$

$$S_{m,flat,LVL\ G-X} = 0,13$$

LVL G-S

$$f_{(LVL\ G-S)m,0,flatwise,k}(b) = f_{(LVL\ G-S)m,flatwise,k}(b_0) \cdot \left(\frac{b_0}{b}\right)^{S_{m,flat,LVL\ G-S}}$$

$$f_{(LVL\ G-S)m,0,flatwise,k}(b) = 45\text{N/mm}^2 \cdot \left(\frac{90\text{mm}}{b}\right)^{0,11} \quad \text{Eq 10}$$

LVL G-X

$$f_{(LVL\ G-X)m,0,flatwise,k}(b) = f_{(LVL\ G-X)m,flatwise,k}(b_0) \cdot \left(\frac{b_0}{b}\right)^{S_{m,flat,LVL\ G-X}}$$

$$f_{(LVL\ G-X)m,0,flatwise,k}(b) = 31\text{N/mm}^2 \cdot \left(\frac{90\text{mm}}{b}\right)^{0,13} \quad \text{Eq 11}$$

When size effect is taken into account, for LVL G type A, the primary LVL values for flatwise bending strength may be a more severe fracture criterion than tension strength in the middle of the outermost lamination. However, when all lamellas of the LVL G have the same grade, the tension strength in the middle of the outermost lamination criterion may be regarded not relevant and it can be enough to evaluate only the flatwise bending strength.



As an alternative according to [9]

In LVL design the volume effect has to be taken into consideration in each case of brittle failure, particularly tensile failure perpendicular to grain, but also for bending or tensile failure parallel to grain and shear. In practical terms, this means the volume effect is crucial in LVL G double-tapered beams, since such beam types are prone to high tensile stresses perpendicular to the grain in the apex zone due to their geometry.

Fracture criteria given in EN 1995-1-1 clause 9.1.1 comprise the check of mean flange design tension stress. Applied to product type A, this means that the design tension stress in the middle of the outermost lamination shall be checked and be below design tension strength parallel to the grain $f_{t,0,d}$.

In the following, a modified bending design of LVL G members of type A based on section 9.1.1 of EN 1995-1-1 is elaborated taking into account a linear interaction of bending and tensile stresses in the outermost primary LVL lamination according to section 6.2.3 of EN 1995-1-1.

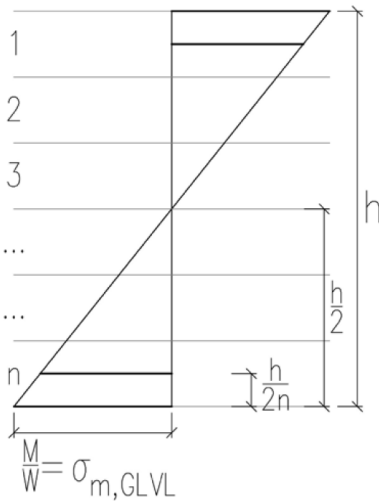

$$f_{(LVL\ G)m,0,flatwise,k} = \frac{1}{\frac{1}{n_L \cdot K_{vol,m} \cdot f_{m,L,flatwise,k}} + \frac{\left(1 - \frac{1}{n_L}\right)}{K_{vol,t} \cdot K_{dis,t} \cdot f_{t,0,L,d}}}$$

$$= \frac{1}{\frac{1}{n_L^{0,925} \cdot f_{m,L,flatwise,k}} + \frac{\left(1 - \frac{1}{n_L}\right)}{K_{vol,t} \cdot K_{dis,t} \cdot f_{t,0,L,d}}}$$

In order to consider the stress distribution in primary LVL laminations, the Weibull theory is applied [9].

The value k_{dis} according to Eq 12 and Eq 13 applies to the outermost LVL lamination in LVL G members loaded in flatwise bending according to EN 408.

LVL G-S

Eq 12

$$f_{(LVL\ G-S)m,0,flatwise,k} = \frac{1}{\frac{1}{n_L^{0,925} \cdot 50N/mm^2} + \frac{\left(1 - \frac{1}{n_L}\right)}{\left(\frac{3000}{L}\right)^{0,075} \cdot 1,18 \cdot 35N/mm^2}}$$

LVL G-X

Eq 13

$$f_{(LVL\ G-X)m,0,flatwise,k} = \frac{1}{\frac{1}{n_L^{0,925} \cdot 36N/mm^2} + \frac{\left(1 - \frac{1}{n_L}\right)}{\left(\frac{3000}{L}\right)^{0,075} \cdot 1,18 \cdot 26N/mm^2}}$$

with

$f_{(LVL\ G)m,0,flatwise,k}$

Characteristic flatwise bending strength of LVL G

$f_{t,0,L,d}$

Characteristic tensile strength parallel to grain of the primary LVL

$f_{m,L,flatwise,k}$

Characteristic flatwise bending strength of the primary LVL

n_L

Number of LVL laminations over the depth of LVL G member

$K_{vol,m}$

Volume factor for flatwise bending of primary LVL $K_{vol,m} = \frac{1}{n_L^{0,075}}$



$K_{vol,t}$	Volume factor for tension parallel to grain of primary LVL $K_{vol,t} = \left(\frac{3000}{L}\right)^{0,075}$
$K_{dis,t}$	Factor taking into account tension parallel to grain stress distribution of primary LVL lamination
$K_{dis,m}$	Factor taking into account bending parallel to grain stress distribution of primary LVL lamination $K_{dis,m} = 1$
L	Length of LVL G member loaded in flatwise bending

Design strength:

LVL G-S

$$f_{(LVL\ G-S),m,0,flat,d} = \frac{k_{mod} \cdot f_{(LVL\ G-S),m,0,flat,k}}{\gamma_{m,LVL-S}} \quad Eq\ 14$$

$f_{(LVL\ G-S),m,0,flat,d}$	Design bending strength for LVL G-S (flatwise)
k_{mod}	Factor, according to EN1995-1-1, Table 3.1, taking a load duration (permanent – very short) and the service class (1-3) into consideration
$f_{(LVL\ G-S),m,0,flat,k}$	Characteristic bending strength of the LVL G-S material, according to [5]
$\gamma_{m,LVL-S}$	Partial safety coefficient, applicable for LVL, according to either EN1995-1-1, Table 2.3, or some local regulations.
$k_{h,flat,LVL\ G-S}$	Already included in $f_{(LVL\ G-S),m,0,flat,k}$

LVL G-X

$$f_{(LVL\ G-X),m,0,flat,d} = \frac{k_{mod} \cdot f_{(LVL\ G-X),m,0,flat,k}}{\gamma_{m,LVL-X}} \quad Eq\ 15$$

$f_{(LVL\ G-X),m,0,flat,d}$	Design bending strength for LVL G-X (flatwise)
$f_{(LVL\ G-X),m,0,flat,k}$	Characteristic bending strength of the LVL G-X material, according to [5]
$\gamma_{m,LVL-X}$	Partial safety coefficient, applicable for LVL, according to either EN1995-1-1, Table 2.3, or some local regulations.
$k_{h,flat,LVL\ G-X}$	Already included in $f_{(LVL\ G-X),m,0,flat,k}$

5.1.2 Edgewise bending strength

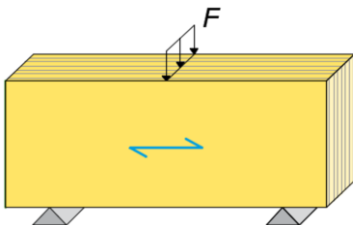

Edgewise bending strength for primary LVL may be used.

LVL G-S

$$f_{(LVL\ G-S),m,0,edge,d} = \frac{k_{mod} \cdot f_{(LVL-S),m,0,edge,k} \cdot k_h}{\gamma_{m,LVL-S}} \quad Eq\ 16$$

$f_{(LVL\ G-S),m,0,edge,d}$	Design bending strength for LVL G-S (edgewise)
k_{mod}	Factor, according to EN1995-1-1, Table 3.1, taking a load duration (permanent – very short) and the service class (1-3) into consideration
$f_{(LVL-S),m,0,edge,k}$	Characteristic bending strength of the LVL-S lamination material, according to [3]



DESIGN MANUAL

Dec-20

$\gamma_{m,LVL-S}$ Partial safety coefficient, applicable for LVL, according to either EN1995-1-1, Table 2.3, or some local regulations.
 k_h Depth factor in bending according to EN 1995-1-1, item 3.4 (3)

LVL G-X

$$f_{(LVL\ G-X),m,0,edge,d} = \frac{k_{mod} \cdot f_{(LVL-X),m,0,edge,k} \cdot k_h}{\gamma_{m,LVL-X}} \quad Eq\ 17$$

$f_{(LVL\ G-X),m,0,edge,d}$ Design bending strength for LVL G-X (edgewise)
 $f_{(LVL-X),m,0,edge,k}$ Characteristic bending strength of the LVL-X lamination material, according to [2]
 $\gamma_{m,LVL-X}$ Partial safety coefficient, applicable for LVL, according to either EN1995-1-1, Table 2.3, or some local regulations.

5.1.3 Bending stress

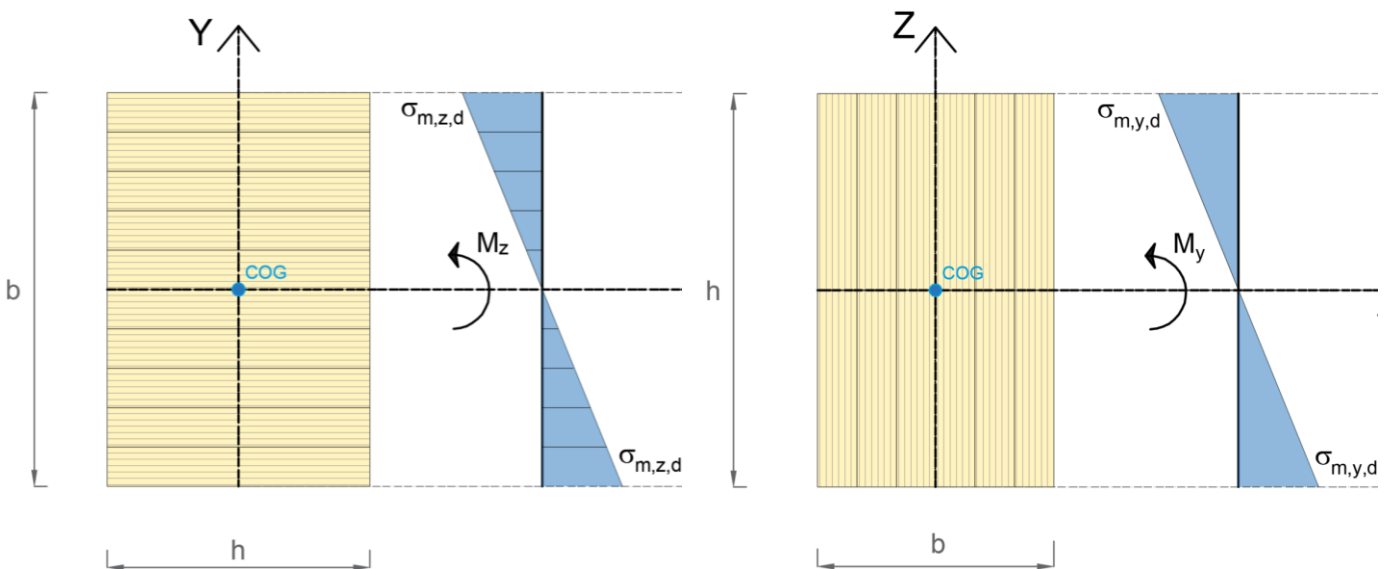

The extreme fiber stress may be calculated as

$$\sigma_{y,i}(x, z) = \frac{E_i \cdot z_i \cdot M_y(x)}{EI_{eff}} \quad Eq\ 18$$

$$\sigma_{z,i}(x, y) = \frac{E_i \cdot y_i \cdot M_z(x)}{EI_{eff}}$$

$$\sigma_y = \frac{M_y \cdot z}{I_y} \quad Eq\ 19$$

$$\sigma_z = \frac{M_z \cdot y}{I_z}$$

$$W_y = \frac{I_y}{z} = \frac{b \cdot h^3}{12} \cdot \frac{2}{h} \quad Eq\ 20$$

$$W_z = \frac{I_z}{y} = \frac{h \cdot b^3}{12} \cdot \frac{2}{b}$$

$$\sigma_{m,y,d} = \frac{M_{y,d}}{W_y} \quad Eq\ 21$$

$$\sigma_{m,z,d} = \frac{M_{z,d}}{W_z}$$



storaenso

$\sigma_{m,y,d}$	Design bending stress at distance x and about the principal axis Y shown in Figure 7 [N/mm ²]
$\sigma_{m,z,d}$	Design bending stress at distance x and about the principal axis Z shown in Figure 7 [N/mm ²]
E_i	Young's Modulus [N/mm ²]
$M_{y,d}$	Bending moment M_y at location x (positive when upper part is compressed)
$M_{z,d}$	Bending moment M_z at location x (positive when upper part is compressed)
z_i	Coordinate z of the point "i" where the stress is being analyzed (distance to neutral axis [mm])
y_i	Coordinate y of the point "i" where the stress is being analyzed (distance to neutral axis [mm])
W_y	Section modulus about Y axis [mm ³]
W_z	Section modulus about Z axis [mm ³]
EI_{eff}	Effective flexural rigidity [N/mm ²]

The stress analysis shall be performed at the top and bottom extreme fibers of the LVL bending member as presented in Figure 7.

Verification (acc to EN1995-1-1 clause 6.1.6)

$$\frac{\sigma_{m,y,d}}{f_{m,y,d}} + k_m \cdot \frac{\sigma_{m,z,d}}{f_{m,z,d}} \leq 1 \quad \text{Eq 22}$$

$$k_m \cdot \frac{\sigma_{m,y,d}}{f_{m,y,d}} + \frac{\sigma_{m,z,d}}{f_{m,z,d}} \leq 1 \quad \text{Eq 23}$$

k_m should be taken as follows

For rectangular sections: $k_m = 0.7$

For other cross sections: $k_m = 1.0$

k_m Factor making allowance for re-distribution of stresses and the effect of the inhomogeneities of the material in the cross section

$f_{m,y,d}$ and $f_{m,z,d}$ refer to $f_{m,0,edge,d}$ and $f_{m,0,flatwise,d}$ of LVL G.

5.2 Bending perpendicular to the grain

5.2.1 Flatwise bending strength

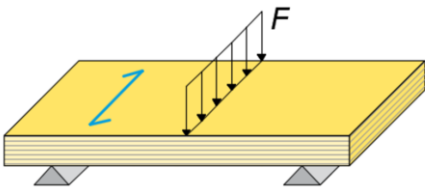

Flatwise bending strength perpendicular to the grain for primary LVL may be used.

$$f_{(LVL\ G-X),m,90,flat,d} = \frac{k_{mod} \cdot f_{(LVL-X),m,90,flat,k}}{\gamma_{m,LVL-X}} \quad \text{Eq 24}$$

$f_{(LVL\ G-X),m,90,flat,d}$ Bending strength flatwise perpendicular to grain for LVL G-X

k_{mod} Factor, according to EN1995-1-1, Table 3.1, taking a load duration (permanent – very short) and the service class (1-3) into consideration

$f_{(LVL-X),m,90,flat,k}$ Characteristic bending strength flatwise perpendicular to grain of LVL-X, according to VTT-S-05550-17)

$\gamma_{m,LVL-X}$ Partial safety coefficient, applicable for LVL, according to either EN1995-1-1, Table 2.3, or some local regulations.

k_{mod} Partial safety coefficient, applicable for LVL, according to EN1995-1-1, Table 2.3



DESIGN MANUAL

Dec-20

Bending moment in cross direction is

$$M_{Ed,90} = \frac{q_d \cdot s^2}{8}$$

$M_{Ed,90}$ Design bending moment on single span case with uniformly distributed loads [kN.m/m]

q_d Design load [kN/m²]

s Spacing between supports in cross direction [m]

5.3 Tension parallel to the grain

5.3.1 Tensile strength



Tensile strength for primary LVL may be used.

$$f_{(LVL\ G-S),t,0,d} = \frac{k_{mod} \cdot f_{(LVL-S),t,0,k} \cdot k_l}{\gamma_{m,LVL-S}} \quad \text{Eq 25}$$

$$f_{(LVL\ G-X),t,0,d} = \frac{k_{mod} \cdot f_{(LVL-X),t,0,k} \cdot k_l}{\gamma_{m,LVL-S}} \quad \text{Eq 26}$$

Where

$f_{(LVL\ G-S),t,0,d}$	Design tensile strength for LVL G-S [N/mm ²]
$f_{(LVL\ G-X),t,0,d}$	Design tensile strength for LVL G-X [N/mm ²]
k_{mod}	Factor, according to EN1995-1-1, Table 3.1, taking a load duration (permanent – very short) and the service class (1-3) into consideration
$f_{(LVL-S),t,0,k}$	Characteristic tensile strength of the LVL-S lamination material, according VTT-S-05710-17)
$f_{(LVL-X),t,0,k}$	Characteristic tensile strength of the LVL-X lamination material, according to VTT-S-05550-17
$\gamma_{m,LVL-S}$	Partial safety coefficient, applicable for LVL, according to either EN1995-1-1, Table 2.3, or some local regulations.
k_l	Member length factor in tension according to EN 1995-1-1, item 3.4 (3), given in Eq 5

5.3.2 Tensile stress and verification

$$\sigma_{t,0,d} = \frac{F_{t,0,d}}{A} \quad \text{Eq 27}$$

$$\sigma_{t,0,d} \leq f_{t,0,d} \quad \text{Eq 28}$$

Where

$F_{t,0,d}$ Design tensile force in grain direction [N]

A Cross sectional area of the LVL G member $A = b \cdot h$ [mm²]

$\sigma_{t,0,d}$ Design tensile stress along the grain [N/mm²]



storaenso

5.4 Tension perpendicular to the grain

5.4.1 Edgewise tensile strength

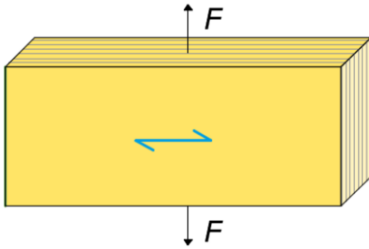

Tensile strength perpendicular to the grain edgewise for primary LVL may be used.

$$f_{(LVL\ G-S),t,90,edge,d} = \frac{k_{mod} \cdot f_{(LVL-S),t,90,edge,k}}{\gamma_{m,LVL-S}} \quad \text{Eq 29}$$

$$f_{(LVL\ G-X),t,90,edge,d} = \frac{k_{mod} \cdot f_{(LVL-X),t,90,edge,k}}{\gamma_{m,LVL-S}} \quad \text{Eq 30}$$

The cross veneers of LVL-X improve the tensile strength perpendicular to the grain in edgewise direction and is better than LVL-S where tension perpendicular to the grain is involved. This strength property is an advantage in suspended connections and between main beams and secondary beams or with diagonal struts.

5.4.2 Flatwise tensile strength

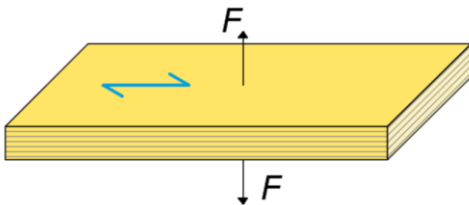

Upon connection of tensile forces transverse to the element plane, the low transverse tensile load bearing capacity must be observed. Tension strength flatwise perpendicular to the grain of LVL-S and LVL-X is low and it is not recommended to design a structure so that the stress in this direction would become critical.

The strength value in this direction declared in the DoP $f_{t,90,flat,k} = 0,20\text{N/mm}^2$ can be used in the design.

Best suited are connections, with which the force is transferred through the element and load application takes place under pressure on that opposite side of the element facing away from the tensile force.

In case of tension perpendicular to the grain, fully threaded screws are suited, screwed into the entire panel thickness, if possible. (Connection design in LVL G is presented in chapter 9)

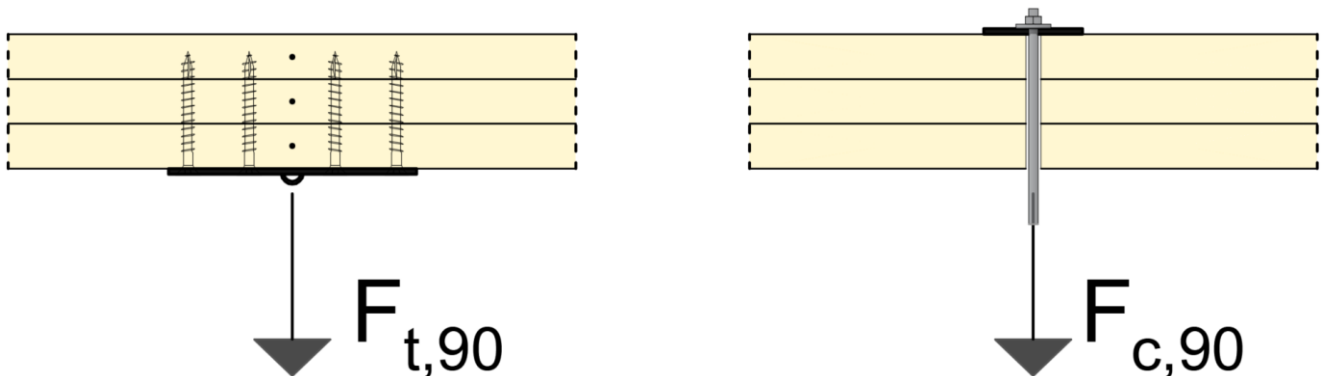

Figure 8: Design example for suspending tension loads



5.4.3 Tensile stress and verification

$$\sigma_{t,90,edge,d} = \frac{F_{t,90,d}}{A} \quad \text{Eq 31}$$

$$\sigma_{t,90,flat,d} = \frac{F_{t,90,d}}{A} \quad \text{Eq 32}$$

$$\sigma_{t,90,d} \leq f_{t,90,edge,d} \quad \text{Eq 33}$$

$$\sigma_{t,90,d} \leq f_{t,90,flat,d} \quad \text{Eq 34}$$

Where

$F_{t,90,d}$ Design tensile force perpendicular to the grain direction [N]

A Area of the LVL G member being in tension perpendicular to the grain [mm²]

$\sigma_{t,90,d}$ Design tensile stress perpendicular to the grain [N/mm²]

5.5 Compression parallel to the grain

5.5.1 Compressive strength



Compression strength parallel to the grain edgewise for primary LVL is used.

LVL G-S

$$f_{(LVL\ G-S),c,0,d} = \frac{k_{mod} \cdot f_{(LVL-S),c,0,k}}{\gamma_{m,LVL-S}} \quad \text{Eq 35}$$

$f_{(LVL\ G-S),c,0,d}$ Design compressive strength for LVL G-S (strength values in SC1 and SC2 are different : see Table 2)

k_{mod} Factor, according to EN1995-1-1, Table 3.1, taking a load duration (permanent – very short) and the service class (1-3) into consideration

$f_{(LVL-S),c,0,k}$ Characteristic compressive strength of the LVL material, according to VTT-S-05710-17)

$\gamma_{m,LVL-S}$ Partial safety coefficient, applicable for LVL, according to either EN1995-1-1, Table 2.3, or some local regulations.

LVL G-X

$$f_{(LVL\ G-X),c,0,d} = \frac{k_{mod} \cdot f_{(LVL-X),c,0,k}}{\gamma_{m,LVL-X}} \quad \text{Eq 36}$$

$f_{(LVL\ G-X),c,0,d}$ Design compressive strength for LVL G-X (strength values in SC1 and SC2 are different : see Table 2)

k_{mod} Factor, according to EN1995-1-1, Table 3.1, taking a load duration (permanent – very short) and the service class (1-3) into consideration

$f_{(LVL-X),c,0,k}$ Characteristic compressive strength of LVL-X, according to VTT-S-05550-17

$\gamma_{m,LVL-X}$ Partial safety coefficient, applicable for LVL, according to EN1995-1-1 [8], Table 2.3



5.5.2 Compressive stress and verification

$$\sigma_{c,0,d} = \frac{F_{c,0,d}}{A} \quad \text{Eq 37}$$

$$\sigma_{c,0,d} \leq k_{c,z} \cdot f_{c,0,d} \quad \text{Eq 38}$$

Where

- $F_{c,0,d}$ Design compressive force in grain direction [N]
- A Cross sectional area of the LVL G member $A = b \cdot h$ [mm²]
- $\sigma_{c,0,d}$ Design compressive stress along the grain [N/mm²]
- $k_{c,z}$ Instability buckling coefficient (see chapter 5.9.3)

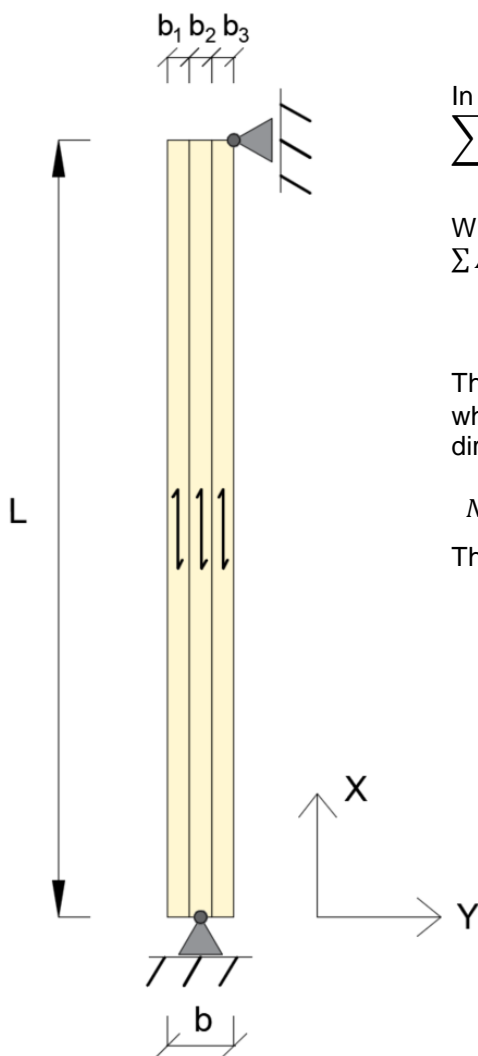

In the example presented in Figure 9:

$$\sum A_i = (A_1 + A_2 + A_3)$$

Where

$\sum A_i$ indicates the sum of the vertical lamella's areas carrying the compressive load.

The corresponding design capacity $N_{c,Rd}$ of the LVL G column when all layers are from the same LVL grade and in the same direction is

$$N_{c,Rd} = k_{c,z} \cdot f_{c,0,d} \cdot \sum A_i \quad \text{Eq 39}$$

The design equation for pure compression is $N_{Ed} \leq N_{c,Rd}$

Figure 9: Cross-section of LVL G column. Example with 3 lamellas ($b_1=b_2=b_3$)

5.6 Compression perpendicular to the grain

5.6.1 Edgewise compressive strength

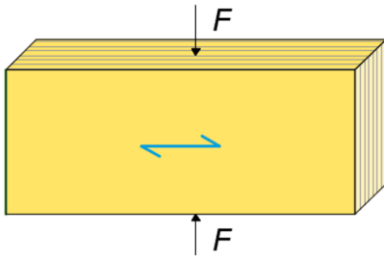

Compression strength perpendicular to grain edgewise for primary LVL is used.

LVL G-S

$$f_{(LVL\ G-S),c,90,edge,d} = \frac{k_{mod} \cdot f_{(LVL-S),c,90,edge,k}}{\gamma_{m,LVL-S}} \quad Eq\ 40$$

$f_{(LVL\ G-S),c,90,edge,d}$	Design edgewise compressive perpendicular to grain strength for LVL G-S
k_{mod}	Factor, according to EN1995-1-1, Table 3.1, taking a load duration (permanent – very short) and the service class (1-3) into consideration
$f_{(LVL-S),c,90,edge,k}$	Characteristic edgewise compressive perpendicular to grain strength of the LVL material, according to VTT-S-05710-17)
$\gamma_{m,LVL-S}$	Partial safety coefficient, applicable for LVL, according to either EN1995-1-1, Table 2.3, or some local regulations.

LVL G-X

$$f_{(LVL\ G-X),c,90,edge,d} = \frac{k_{mod} \cdot f_{(LVL-X),c,90,edge,k}}{\gamma_{m,LVL-X}} \quad Eq\ 41$$

$f_{(LVL\ G-X),c,90,edge,d}$	Design edgewise compressive perpendicular to grain strength for LVL G-X
k_{mod}	Factor, according to EN1995-1-1, Table 3.1, taking a load duration (permanent – very short) and the service class (1-3) into consideration
$f_{(LVL-X),c,90,edge,k}$	Characteristic edgewise compressive perpendicular to grain strength of LVL-X, according to VTT-S-05550-17
$\gamma_{m,LVL-X}$	Partial safety coefficient, applicable for LVL, according to EN1995-1-1 [8], Table 2.3

5.6.2 Flatwise compressive strength

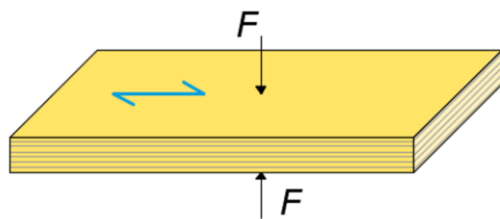

Compression strength perpendicular to grain flatwise for primary LVL is used.

LVL G-S

$$f_{(LVL\ G-S),c,90,flat,d} = \frac{k_{mod} \cdot f_{(LVL-S),c,90,flat,k}}{\gamma_{m,LVL-S}} \quad Eq\ 42$$

$f_{(LVL\ G-S),c,90,flat,d}$	Design flatwise compressive perpendicular to grain strength for LVL G-S
------------------------------	---



DESIGN MANUAL

Dec-20

k_{mod}	Factor, according to EN1995-1-1, Table 3.1, taking a load duration (permanent – very short) and the service class (1-3) into consideration
$f_{(LVL-S),c,90,flat,k}$	Characteristic flatwise compressive perpendicular to grain strength of the LVL material, according to VTT-S-05710-17)
$\gamma_{m,LVL-S}$	Partial safety coefficient, applicable for LVL, according to either EN1995-1-1, Table 2.3, or some local regulations.

LVL G-X

$$f_{(LVL\ G-X),c,90,flat,d} = \frac{k_{mod} \cdot f_{(LVL-X),c,90,flat,k}}{\gamma_{m,LVL-X}} \quad Eq\ 43$$

$f_{(LVL\ G-X),c,90,flat,d}$	Design flatwise compressive perpendicular to grain strength for LVL G-X
k_{mod}	Factor, according to EN1995-1-1, Table 3.1, taking a load duration (permanent – very short) and the service class (1-3) into consideration
$f_{(LVL-X),c,90,flat,k}$	Characteristic flatwise compressive perpendicular to grain strength of LVL-X, according to VTT-S-05550-17
$\gamma_{m,LVL-X}$	Partial safety coefficient, applicable for LVL, according to EN1995-1-1 [8], Table 2.3

5.6.3 Compressive stress and verification of bearing pressure strength

The following expression shall be satisfied

Edgewise

$$\sigma_{c,90,d} \leq k_{c,90} \cdot f_{c,90,edge,d} \quad Eq\ 44$$

Flatwise

$$\sigma_{c,90,d} \leq k_{c,90} \cdot f_{c,90,flat,d} \quad Eq\ 45$$

Where

$k_{c,90}$	Factor considering the load configuration, the possibility of splitting and the degree of compressive deformation
$f_{c,90,d}$	Design compressive strength perpendicular to the grain [N/mm ²]

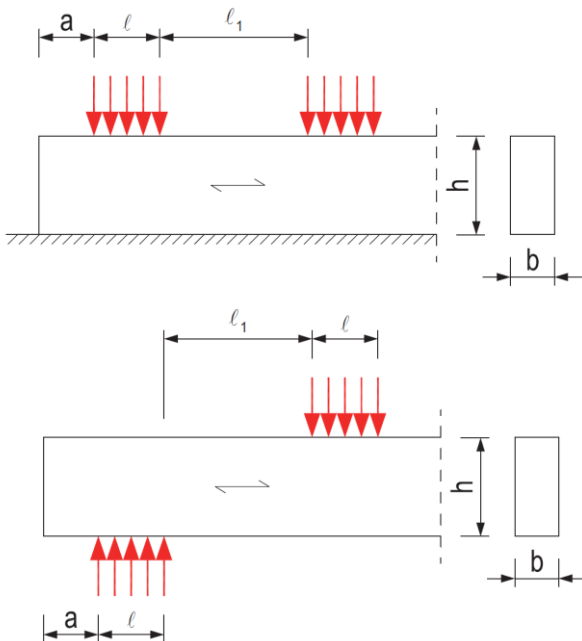

Figure 10: Member on continuous (top) and discrete supports (bottom) (LVL Handbook [10])

Eurocode 5 does not include the parameters $k_{c,90}$ and A_{ef} for LVL in different orientations of the material yet.

The value of $k_{c,90}$ should be taken as 1,0 for LVL in the edgewise loading direction and in the flatwise loading direction, $k_{c,90} = 1,4$ may be used, when the distance $l_1 \geq 2h$.

DESIGN MANUAL

Dec-20

Design compressive stress may be calculated as

$$\sigma_{c,90,d} = \frac{F_{c,90,d}}{A_{ef}} \quad \text{Eq 46}$$

Where

- $\sigma_{c,90,d}$ is the design bearing pressure, in the effective contact area perpendicular to the grain [N/mm²]
- $F_{c,90,d}$ is equal to design compressive force perpendicular to the grain, (e.g reaction support) [N]
- A_{ef} is the effective contact area in compression perpendicular to the grain [mm²]

The effective contact area perpendicular to the grain, A_{ef} , should be determined considering an effective contact length parallel to the grain, where the modified contact length, L_s , at each side is increased. But not more than a , l or $l_1/2$.

The factors $k_{c,90}$ is taken as follows:

Table 8: Factor $K_{c,90}$ and contact length for LVL G

Direction		$k_{c,90}$	Increase of the contact length [mm]
Compression perpendicular to the grain			
Edgewise		1,0	$l_{1,edge} = 15mm$
$f_{c,90,edge,k}$			
Flatwise	Parallel to the grain of the surface veneers	1,4	$l_{1,flat} = 30mm$
	Perpendicular to the grain of the surface veneers		$l_2 = 15mm$
$f_{c,90,flat,k}$			

The increased contact length and factor $k_{c,90}$ are less favorable for LVL in edgewise direction, than in the flatwise direction or compared to other wood products, due to the failure behavior of the product. LVL in the flatwise direction has ductile behavior under compression perpendicular to the grain.

The effective contact area may be calculated as follows:

$l_{ef,1} = l_{s1} + l_{1,flat}$	For end support in grain direction (flatwise)	Eq 47
$l_{ef,1} = l_{s1} + l_{1,edge}$	For end support in grain direction (edgewise)	Eq 48
$l_{ef,1} = l_{s1} + 2 \cdot l_{1,flat}$	For intermediate support in grain direction (flatwise)	Eq 49
$l_{ef,1} = l_{s1} + 2 \cdot l_{1,edge}$	For intermediate support in grain direction (edgewise)	Eq 50
$l_{ef,2} = l_{s2} + l_2$	For point edge support in cross direction (flatwise)	Eq 51
$l_{ef,2} = l_{s2} + 2 \cdot l_2$	For point central support in cross direction (flatwise)	Eq 52
$l_{ef,1} = l + l_{1,flat}$	For end point load, in grain direction (flatwise)	Eq 53
$l_{ef,1} = l + l_{1,edge}$	For end point load, in grain direction (edgewise)	Eq 54
$l_{ef,1} = l + 2 \cdot l_{1,flat}$	For intermediate point load, in grain direction (flatwise)	Eq 55
$l_{ef,1} = l + 2 \cdot l_{1,edge}$	For intermediate point load, in grain direction (edgewise)	Eq 56

Where

- $l_{ef,1}$ is the effective spreading length in grain direction [mm]
- $l_{ef,2}$ is the effective spreading length in cross direction [mm]
- l_{s1} is the width of the support in grain direction [mm]
- l_{s2} is the width of the support in cross direction [mm]
- $l_{1,flat}$ increased contact length parallel to the grain on LVL flatwise [mm]
- $l_{1,edge}$ increased contact length parallel to the grain on LVL edgewise [mm]
- l_2 increased contact length in cross direction on LVL flatwise [mm]
- l is the length of the applied force in grain/cross direction when the member is loaded from the top [mm]

See Figure 11 for members supported on full width and Figure 15 & Figure 16 for point discretely supported member.



storaenso

5.6.4 Effective spreading length of a supported and loaded beam member

Type Flatwise

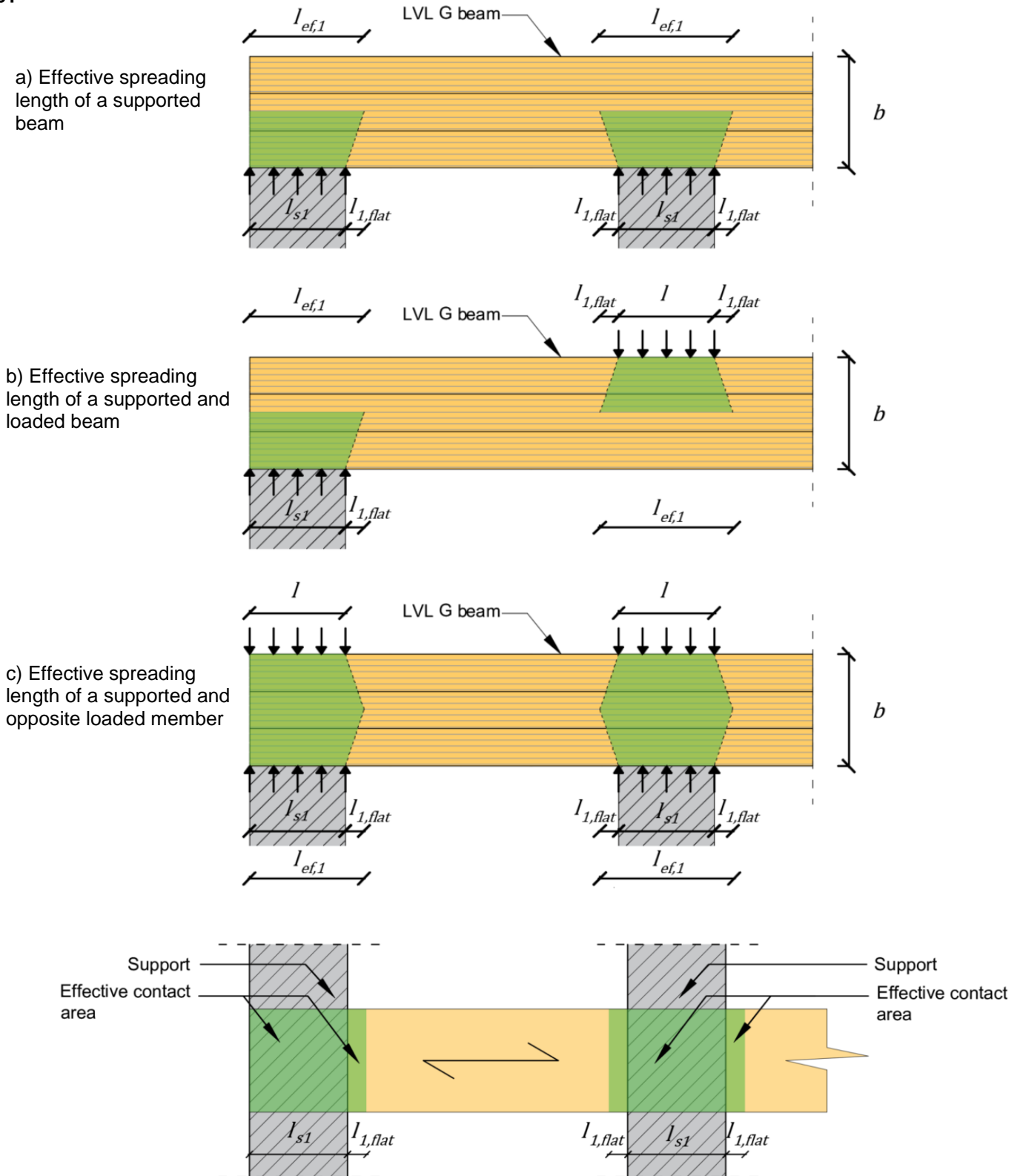

Figure 11: Effective spreading length of a supported and loaded flatwise beam in different configurations



DESIGN MANUAL

Dec-20

Type Edgewise

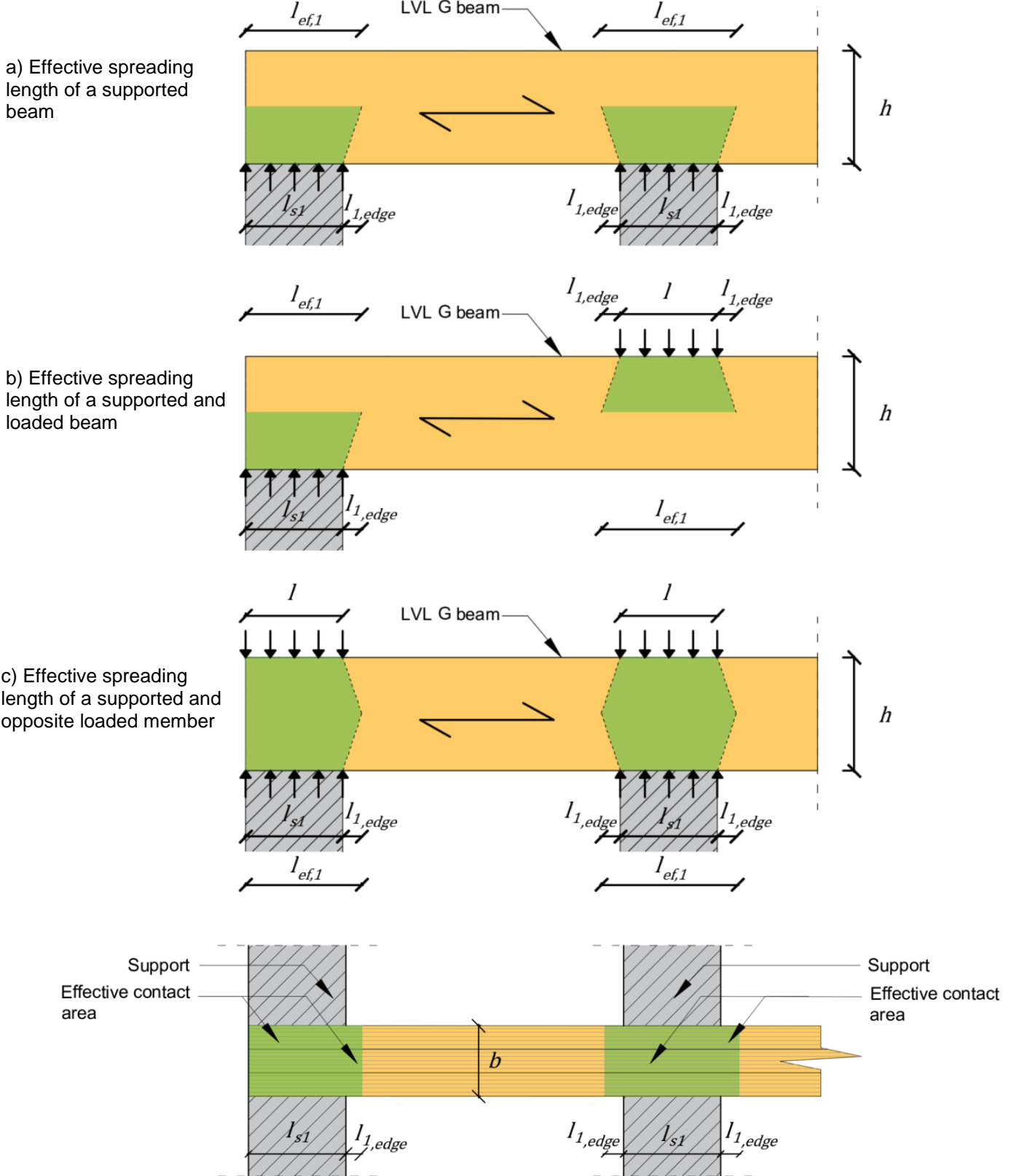

Figure 12: Effective spreading length of a supported and loaded edgewise beam in different configurations



LVL G edgewise beam with an end support

$$A_{ef,edge} = b \cdot (l_{s1} + l_{1,edge})$$

Eq 57

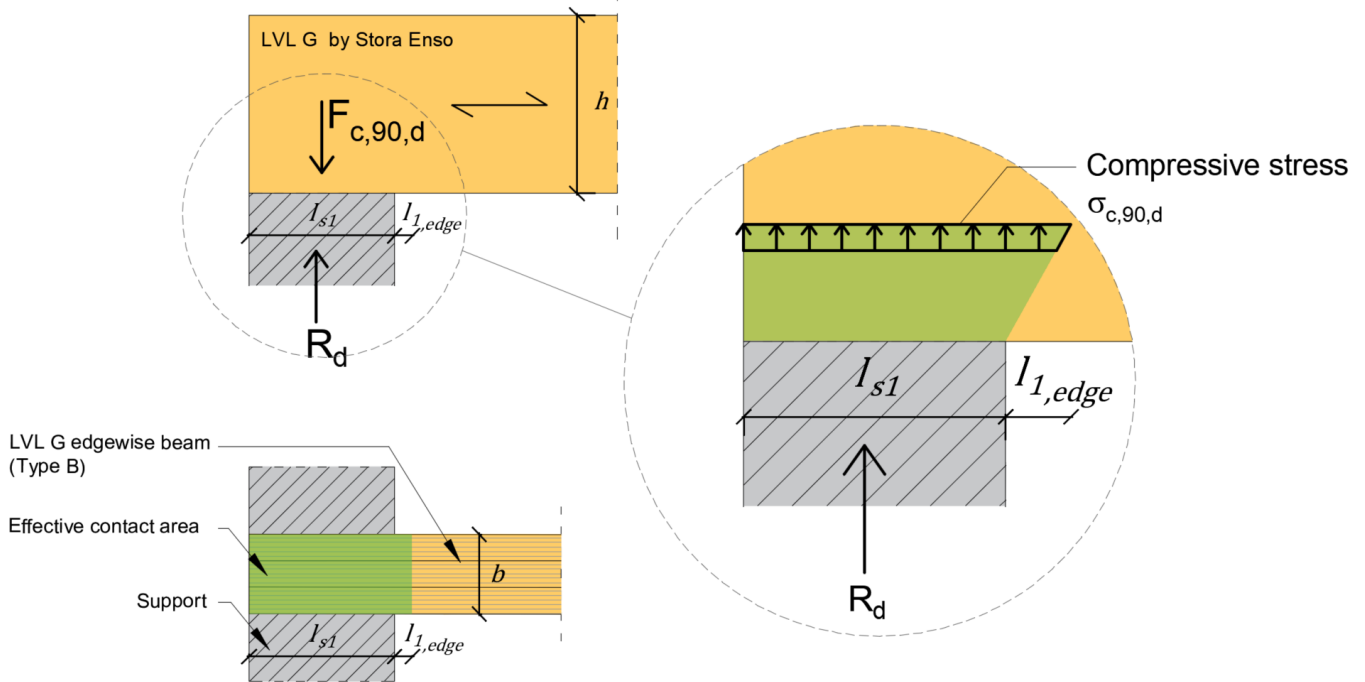

Figure 13: Load bearing contact surface on LVL G edgewise beam

LVL G flatwise beam with an end support

$$A_{ef,flat} = h \cdot (l_{s1} + l_{1,flat})$$

Eq 58

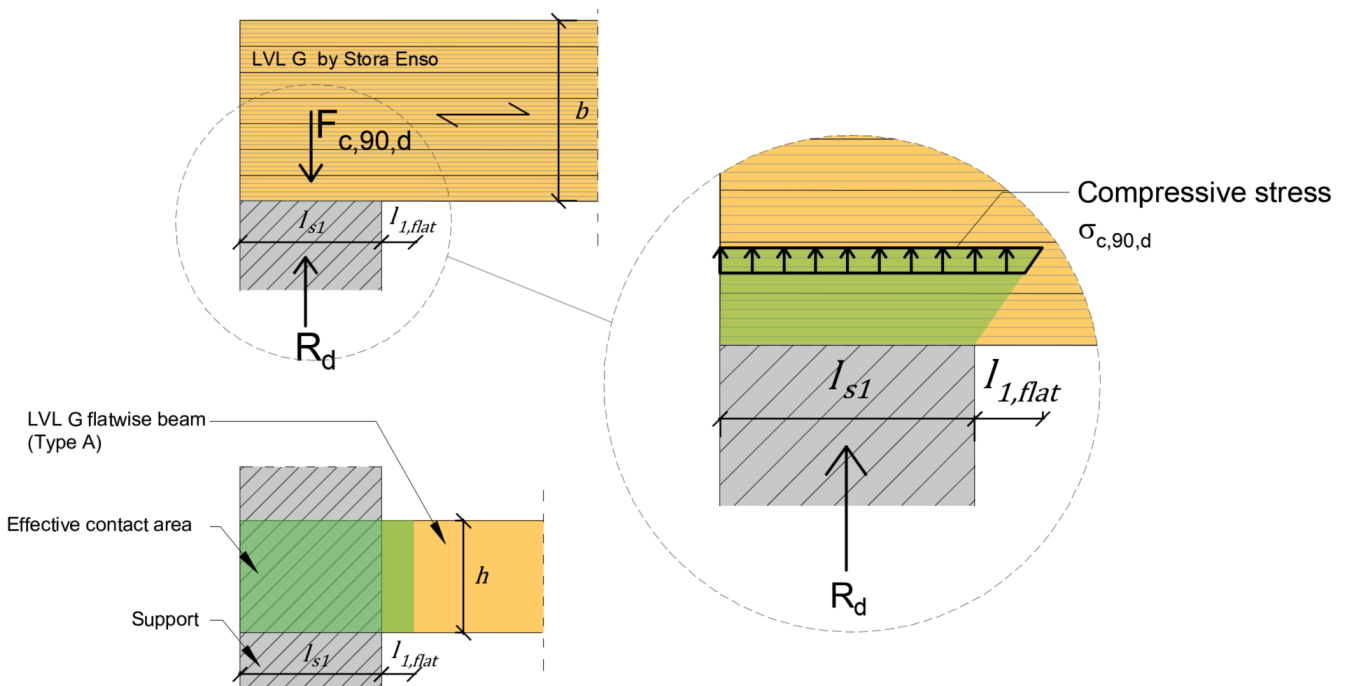

Figure 14: Load bearing contact surface on LVL G flatwise beam with continuous support

LVL G flatwise beam with an end point support: in grain and cross direction

$$A_{ef,flat} = l_{s1} \cdot (l_{s2} + 2 \cdot l_2) + l_{1,flat} \cdot l_{s2} \quad \text{Eq 59}$$

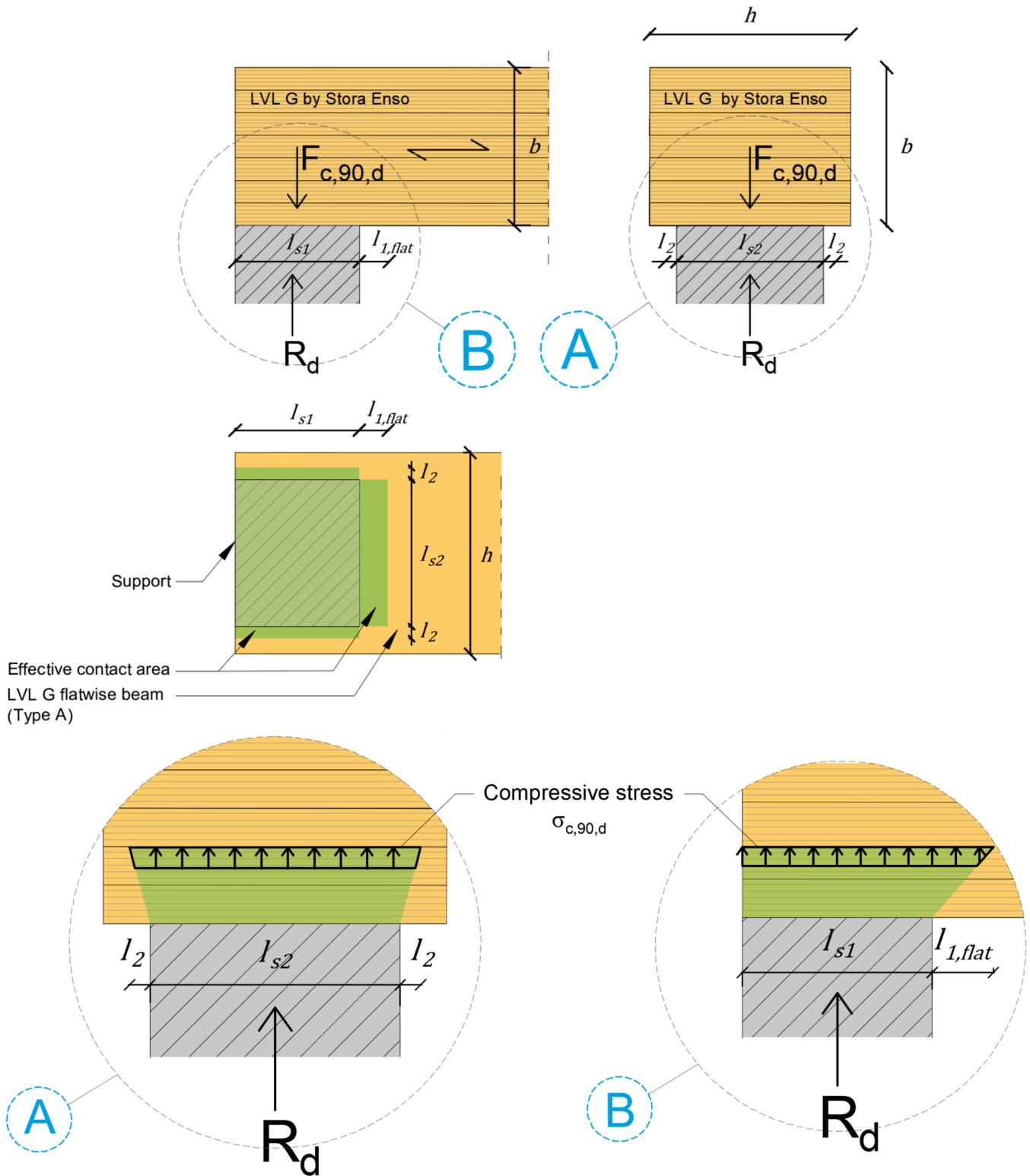

Figure 15: Load bearing contact surface on LVL G flatwise beam with point support

In Figure 13, Figure 14 and Figure 15 is shown the effective contact surface at the supports.

5.6.5 Effective spreading length of a point discretely supported and loaded member

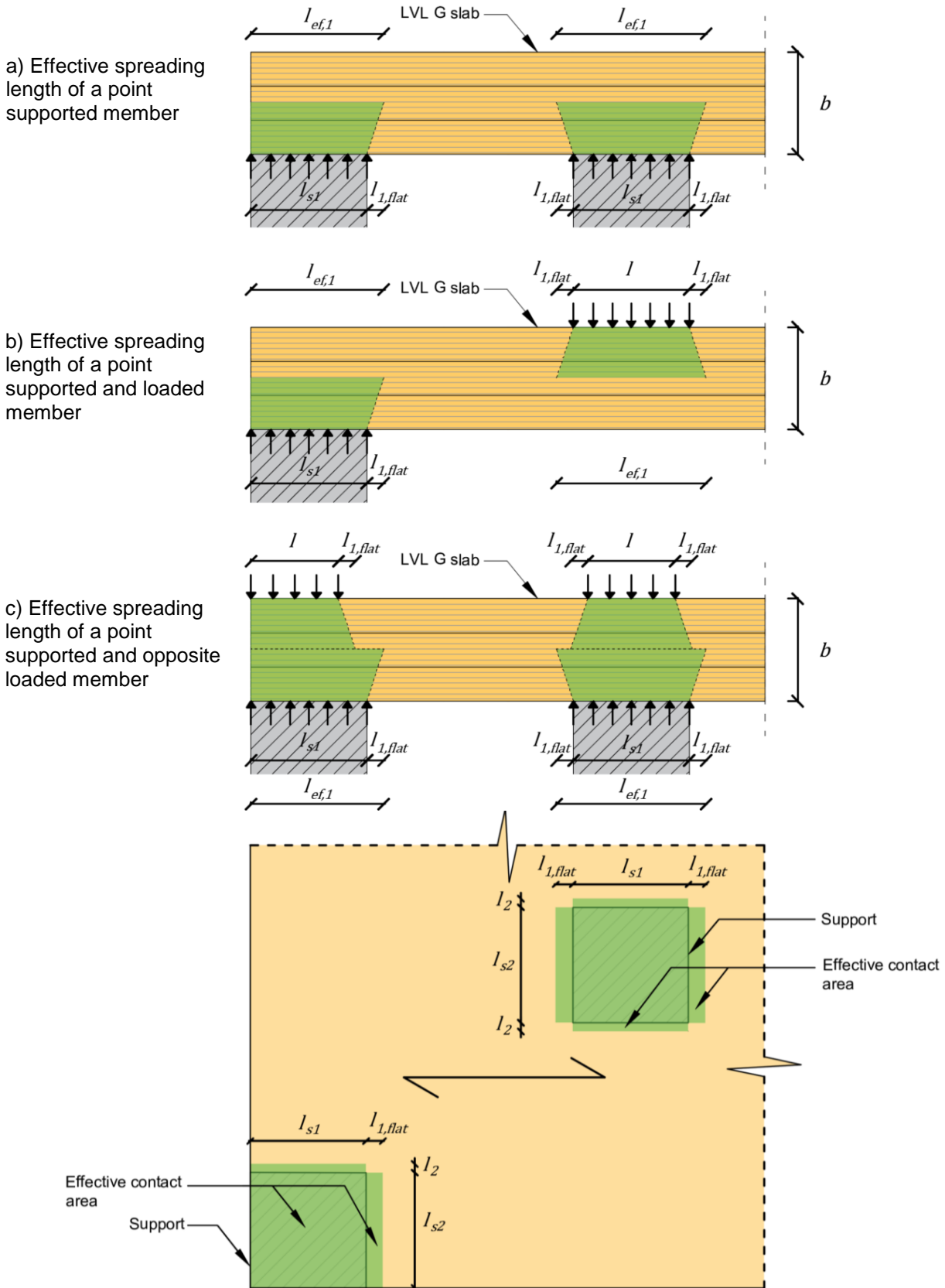

Figure 16: Load bearing contact surface of LVL G slab with point supports (edge and central location)



In Figure 16 and Figure 17 is shown the effective contact surface at the supports.

LVL G slab with end and intermediate point support in edge and central location (Figure 16): flatwise in both direction

$$A_{ef,flat} = l_{s1} \cdot (l_{s2} + l_2) + l_{1,flat} \cdot l_{s2} \quad \text{At edge location} \quad \text{Eq 60}$$

$$A_{ef,flat} = l_{s1} \cdot (l_{s2} + 2 \cdot l_2) + 2 \cdot l_{1,flat} \cdot l_{s2} \quad \text{At central location} \quad \text{Eq 61}$$

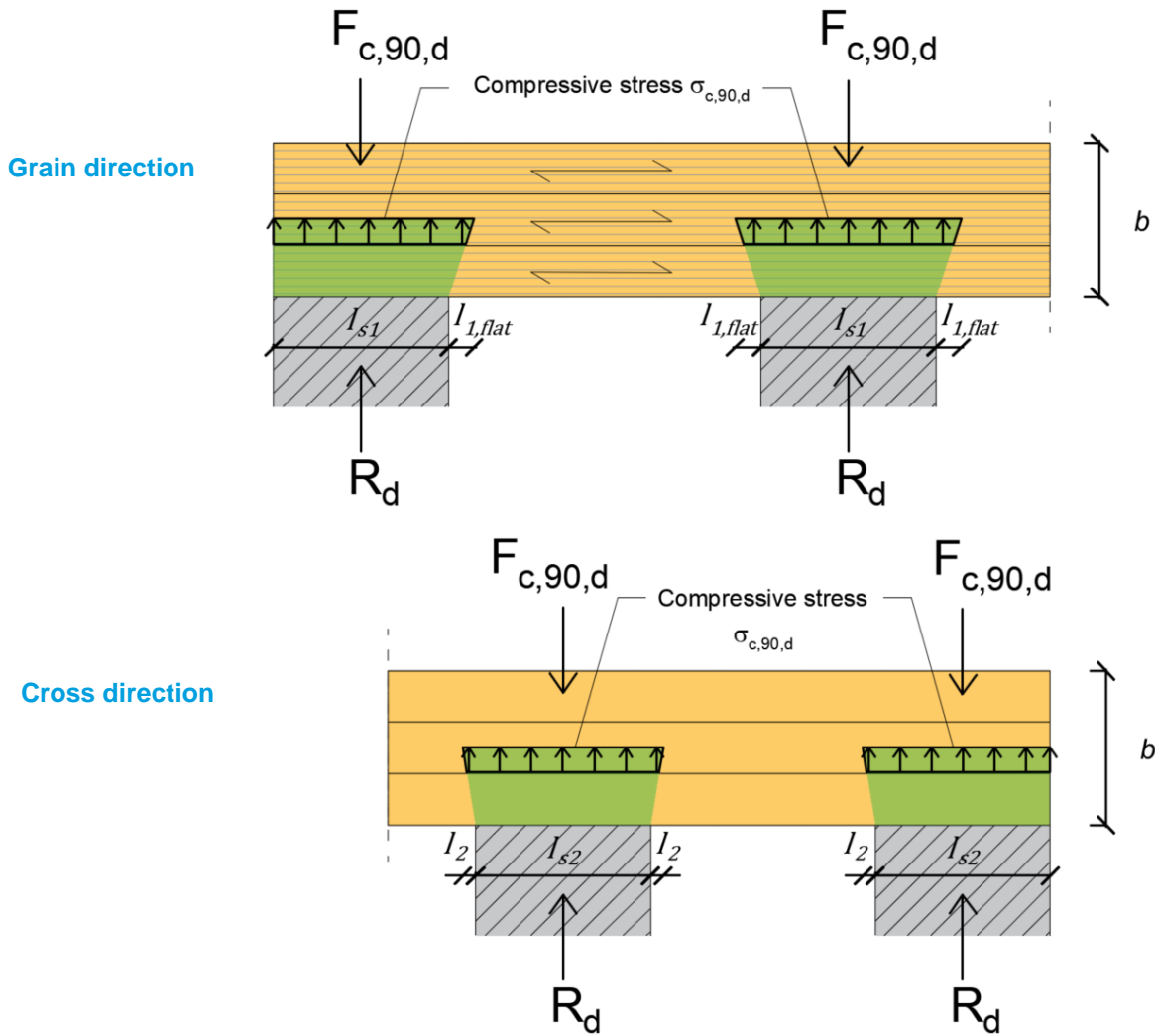

Figure 17: Load bearing contact surface of LVL G slab with point supports in both direction (at edge and central location) - Compressive stress

5.7 Bending stress at an angle α to the grain

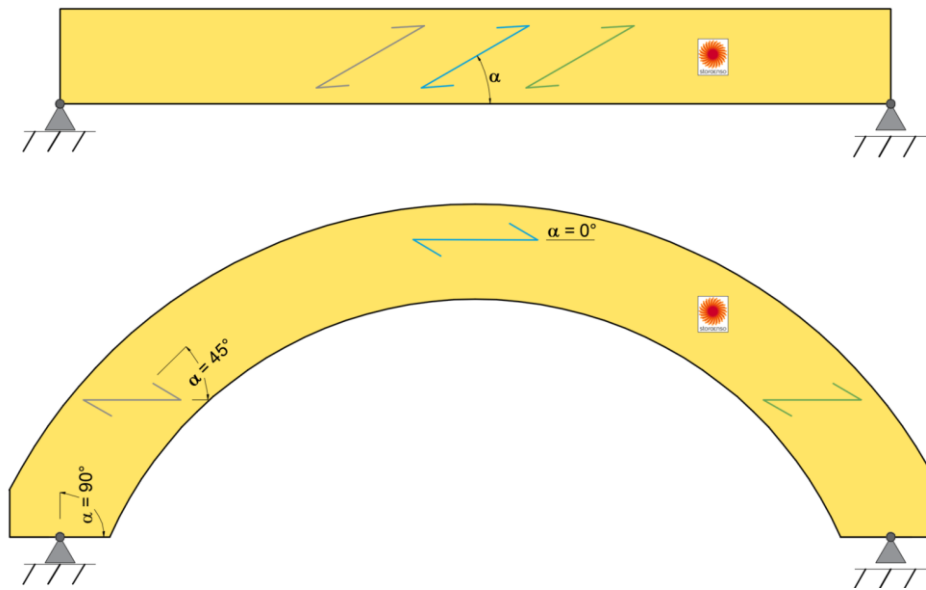

Figure 18: Angle α between span direction and grain direction of LVL G lamellas (example with 3 layers LVL G (blue -grey-green colours))

The bending stresses at an angle α to the grain should satisfy the following expression Eq 62:

$$\sigma_{m,\alpha,d} \leq \frac{f_{m,0,d}}{\frac{f_{m,0,d}}{f_{m,90,d}} \cdot \sin^2 \alpha + \frac{f_{m,0,d}}{f_{v,d}} \cdot \sin \alpha \cdot \cos \alpha + \cos^2 \alpha} \quad \text{Eq 62}$$

where

- $\sigma_{m,\alpha,d}$ is the design bending stress at an angle α to the grain [N/mm²]
- $f_{m,90,d}$ is the design tensile strength perpendicular to grain value $f_{t,90,d}$ which should be used as $f_{m,90,d}$ for LVL G (edgewise) [N/mm²]
- $f_{m,0,d}$ is the design bending strength parallel to grain for LVL G (edgewise) [N/mm²]
- $f_{v,d}$ is the design shear strength for LVL G (edgewise) [N/mm²]

(See Annex 14.2 for equation derivation)

5.8 Compressive and tensile stress at an angle α to the grain

5.8.1 Compression strength at an angle to the grain

Both compressive and tensile stresses can also occur under an angle to the grain, whereby the angle between the load and grain directions is termed angle α . Hankinson (1921) proposed the following equation Eq 63 for the strength values $f_{c,\alpha}$ assuming linear interaction. (For the derivation of the Hankinson equation, see Annex 14.2.)

$$f_{c,\alpha,d} \leq \frac{f_{c,0,d} \cdot f_{c,90,d}}{f_{c,0,d} \cdot \sin^2 \alpha + f_{c,90,d} \cdot \cos^2 \alpha} \quad \text{Eq 63}$$

For small angles α , the strength significantly depends on changes to the angle. Small changes in the slope of grain result in a considerable change in strength, particularly for tensile strength. [11]

To determine the tension strength at an angle α to the grain, a corresponding expression is used, when replacing f_c with f_t (see Eq 64).



5.8.2 Verification of compressive stress at an angle α to the grain

When verifying compression at an angle to the grain, equation Eq 64 applies, which corresponds to the Hankinson equation Eq 63, although in this case, coefficient $K_{c,90}$ is also considered \rightarrow (can also be found in EN1995 1-1 clause 6.2.2):

$$\sigma_{c,\alpha,d} \leq \frac{f_{c,0,d}}{\frac{f_{c,0,d}}{K_{c,90} \cdot f_{c,90,d}} \cdot \sin^2 \alpha + \cos^2 \alpha} \quad \text{Eq 64}$$

where

- $\sigma_{c,\alpha,d}$ is the design compressive stress at an angle α to the grain [N/mm²]
- $f_{c,90,d}$ is the design compressive strength perpendicular to grain for LVL G (edgewise) [N/mm²]
- $f_{c,0,d}$ is the design compressive strength parallel to grain for LVL G [N/mm²]
- $K_{c,90}$ See chapter 5.6

The verifications for compression stress cited here only apply to members not at risk of buckling. Shear strength $f_{v,d}$ is not used in equation Eq 64, but is used in next equation Eq 65 to verify tensile stresses at an angle to the grain.

5.8.3 Tension at an angle to the grain

EC 5 does not specify any means of verifying tensile capacity perpendicular to the grain ($\alpha = 90^\circ$), except that the member size has to be taken into consideration. Tensile stresses perpendicular to the grain tend to occur in curved beams, double tapered beams, notched beams, beams with holes or joints loaded perpendicular to the grain.

EC 5 also excludes details on tension at an angle α to the grain, although some NA propose a means of verifying this type of stress.

Stresses at an angle to the grain result in combined stress conditions, under which both tensile stresses parallel and perpendicular to the grain and shear stresses occur, which is why the Hankinson equation Eq 63 was expanded to encompass shear strength (For the derivation of the Hankinson equation, see Annex 14.2.) and is then used to convert longitudinal tensile strength to tensile strength at an angle α to the grain:

$$\sigma_{t,\alpha,d} \leq K_\alpha \cdot f_{t,0,d} = \frac{1}{\frac{f_{t,0,d}}{f_{t,90,d}} \cdot \sin^2 \alpha + \frac{f_{t,0,d}}{f_{v,d}} \cdot \sin \alpha \cdot \cos \alpha + \cos^2 \alpha} \cdot f_{t,0,d} \quad \text{Eq 65}$$

where

- $\sigma_{t,\alpha,d}$ is the design tensile stress at an angle α to the grain [N/mm²]
- $f_{t,90,d}$ is the design tensile strength perpendicular to grain for LVL G (edgewise) [N/mm²]
- $f_{t,0,d}$ is the design tensile strength parallel to grain for LVL G [N/mm²]
- $f_{v,d}$ is the design shear strength for LVL G (edgewise) [N/mm²]

To verify tension in the grain direction, see chapter 5.3.



5.9 Stability of LVL G members

5.9.1 Members subjected to combined bending and axial compression or tension

Combined bending and axial compression

Verification (acc to EN1995-1-1 item 6.2.4)

$$\left(\frac{\sigma_{c,0,d}}{f_{c,0,d}}\right)^2 + \frac{\sigma_{m,y,d}}{k_{m,\alpha} \cdot f_{m,y,d}} + k_m \cdot \frac{\sigma_{m,z,d}}{f_{m,z,d}} \leq 1 \quad \text{Eq 66}$$

$$\left(\frac{\sigma_{c,0,d}}{f_{c,0,d}}\right)^2 + k_m \cdot \frac{\sigma_{m,y,d}}{k_{m,\alpha} \cdot f_{m,y,d}} + \frac{\sigma_{m,z,d}}{f_{m,z,d}} \leq 1 \quad \text{Eq 67}$$

k_m is given in chapter 5.1.3

$k_{m,\alpha}$ is the factor for combined stresses in tapered beams (See chapter 6) : $k_{m,\alpha} = 1$ for straight beams

Combined bending and axial tension

Verification (acc to EN1995-1-1 item 6.2.3)

$$\left(\frac{\sigma_{t,0,d}}{f_{t,0,d}}\right) + \frac{\sigma_{m,y,d}}{k_{m,\alpha} \cdot f_{m,y,d}} + k_m \cdot \frac{\sigma_{m,z,d}}{f_{m,z,d}} \leq 1 \quad \text{Eq 68}$$

$$\left(\frac{\sigma_{t,0,d}}{f_{t,0,d}}\right) + k_m \cdot \frac{\sigma_{m,y,d}}{k_{m,\alpha} \cdot f_{m,y,d}} + \frac{\sigma_{m,z,d}}{f_{m,z,d}} \leq 1 \quad \text{Eq 69}$$

5.9.2 Oblique bending

If LVL G elements with an inclined pitch are used, as for example, pitched roof elements, then as a consequence of vertical load, the stress consists of one portion of bending about Y axis and one portion of bending about Z axis. (see chapter 5.1.3)

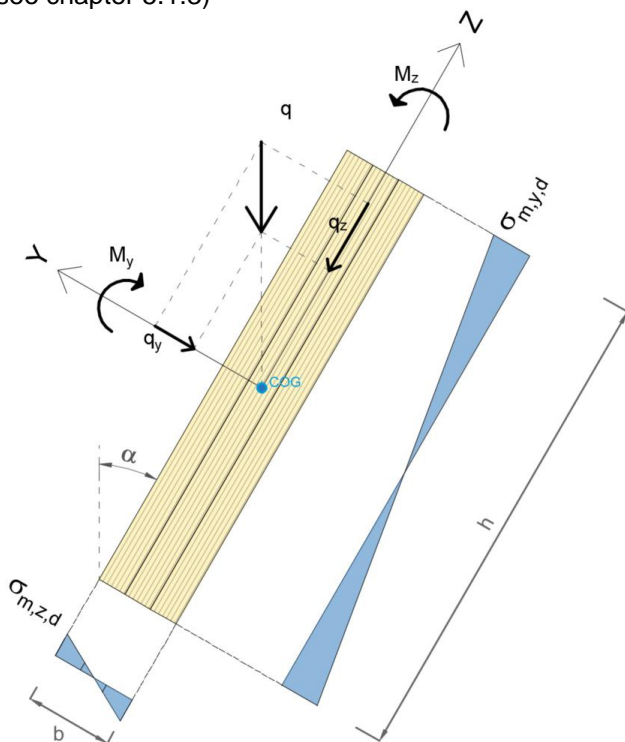

$$q_y = q \cdot \sin \alpha \quad \text{Force component in Y direction [kN/m]}$$

$$q_z = q \cdot \cos \alpha \quad \text{Force component in Z direction [kN/m]}$$

Figure 19; Oblique bending of pitched LVL G beam



Verification of combined bending (acc to EN1995-1-1 clause 6.1.6)

$$\frac{\sigma_{m,y,d}}{f_{m,y,d}} + k_m \cdot \frac{\sigma_{m,z,d}}{f_{m,z,d}} \leq 1 \quad \text{Eq 70}$$

$$k_m \cdot \frac{\sigma_{m,y,d}}{f_{m,y,d}} + \frac{\sigma_{m,z,d}}{f_{m,z,d}} \leq 1 \quad \text{Eq 71}$$

k_m should be taken as follows:

For rectangular sections: $k_m = 0.7$

For other cross sections: $k_m = 1.0$

k_m Factor making allowance for re-distribution of stresses and the effect of the inhomogeneities of the material in the cross section

$f_{m,y,d}$ and $f_{m,z,d}$ refer to $f_{m,0,edge,d}$ and $f_{m,0,flatwise,d}$ of LVL G.

When the LVL G element longitudinal X-axis is inclined, the panel will be under combined bending and axial compression. In this case, the design equation presented in the chapter 5.9.1 should be applied.

5.9.3 Buckling of LVL G columns subjected to either compression or combined compression and bending

Condition according to EN1995-1-1 [8], item 6.3.2 needs to be fulfilled. Column stability and lateral torsional stability shall be verified using the characteristic properties $E_{0,k}$. This applies to the LVL G-X as well as to the LVL G-S.

Verification (acc to EN1995-1-1 clause 6.3.2)

When both $\lambda_{rel,y} \leq 0,3$ and $\lambda_{rel,z} \leq 0,3$ the stresses should satisfy the equations Eq 66 and Eq 67 of combined bending and axial compression, meaning that in this case, buckling will not have any effect.

In all other cases when $\lambda_{rel} > 0,3$ the stresses, which will be increased due to deflection, should satisfy the following expressions Eq 72 and Eq 73:

$$\left(\frac{\sigma_{c,0,d}}{k_{c,y} \cdot f_{c,0,d}} \right) + \frac{\sigma_{m,y,d}}{k_{m,\alpha} \cdot f_{m,y,d}} + k_m \cdot \frac{\sigma_{m,z,d}}{f_{m,z,d}} \leq 1 \quad \text{Eq 72}$$

$$\left(\frac{\sigma_{c,0,d}}{k_{c,z} \cdot f_{c,0,d}} \right) + k_m \cdot \frac{\sigma_{m,y,d}}{k_{m,\alpha} \cdot f_{m,y,d}} + \frac{\sigma_{m,z,d}}{f_{m,z,d}} \leq 1 \quad \text{Eq 73}$$

Where

The relative slenderness ratios should be calculated as

$$\lambda_{rel,y} = \frac{\lambda_y}{\pi} \cdot \sqrt{\frac{f_{c,0,k}}{E_{0,05,y}}} \quad \text{Eq 74}$$

$$\lambda_{rel,z} = \frac{\lambda_z}{\pi} \cdot \sqrt{\frac{f_{c,0,k}}{E_{0,05,z}}}$$

Where

λ_y and $\lambda_{rel,y}$ Slenderness ratios corresponding to bending about y axis (deflection in the z direction)

λ_z and $\lambda_{rel,z}$ Slenderness ratios corresponding to bending about z axis (deflection in the y direction)

$E_{0,05}$ Characteristic value of the modulus of elasticity parallel to the grain.



$$k_{c,y} = \frac{1}{k_y + \sqrt{k_y^2 - \lambda_{rel,y}^2}} \quad \text{Eq 75}$$

$$k_{c,z} = \frac{1}{k_z + \sqrt{k_z^2 - \lambda_{rel,z}^2}} \quad \text{Eq 76}$$

$$k_y = 0,5 \cdot (1 + \beta_c \cdot (\lambda_{rel,y} - 0,3) + \lambda_{rel,y}^2) \quad \text{Eq 77}$$

$$k_z = 0,5 \cdot (1 + \beta_c \cdot (\lambda_{rel,z} - 0,3) + \lambda_{rel,z}^2) \quad \text{Eq 78}$$

β_c is a factor for members within straightness limit
 $\beta_c = 0,10$ for LVL within the straightness limit of $L/500$

The limit is defined in Eurocode5 section 10 as the deviation from straightness measured midway between the supports of members where lateral instability can occur.

k_c is the instability buckling coefficient calculated according to the equations above and EN1995-1-1 [8] (6.3.2).
 Radius of gyration:

$$i_y = \sqrt{\frac{EI_{ef}}{EA}} = \sqrt{\frac{I_y}{A}} \quad \text{Eq 79}$$

$$i_z = \sqrt{\frac{EI_{ef}}{EA}} = \sqrt{\frac{I_z}{A}} \quad \text{Eq 80}$$

The moment of inertia should be taken according to the direction of the buckling analysis.

Slenderness ratio:

$$\lambda_y = \frac{l_{ef,y}}{i_y} \quad \text{Eq 81}$$

$$\lambda_z = \frac{l_{ef,z}}{i_z} \quad \text{Eq 82}$$

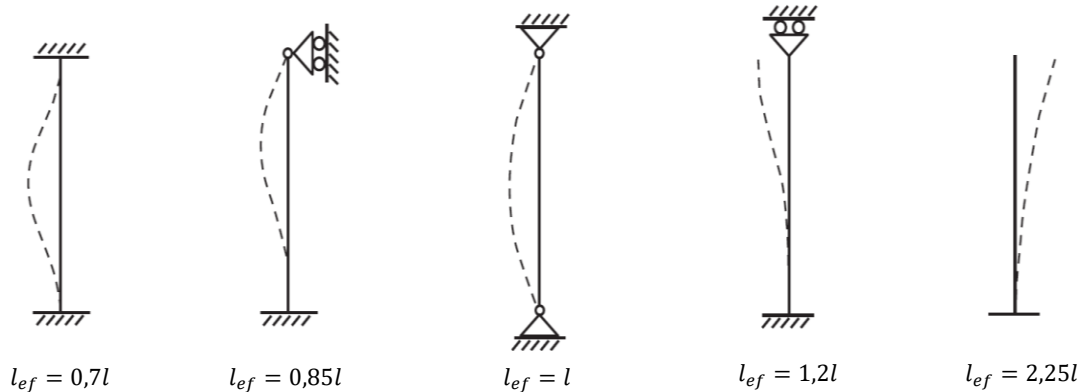
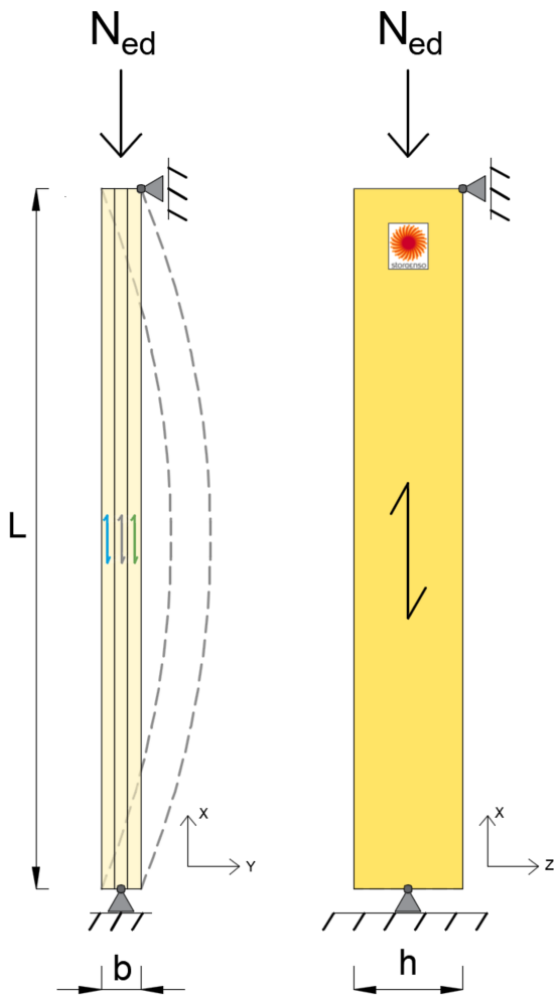

Figure 20: Column effective buckling length l_{ef} for different end conditions. l is actual column length.



l_{ef} Effective length [mm]

Examples of values for the buckling lengths that can be used in practical design are given in Figure 20.

The values are slightly higher than the theoretical values given by Euler theory because consideration has to be taken to uncertainties in boundary conditions.

Buckling will occur about the axis with the highest slenderness ratio. The effective length l_{ef} (or buckling length) of a compression member is the distance along its length between adjacent points of contra-flexure, where the bending moment in the member is zero.

Figure 21: LVL G column buckling

Buckling of columns: Upon execution of very narrow wall columns, it must be checked whether buckling in the element plane, i.e. about the Y axis, becomes decisive.

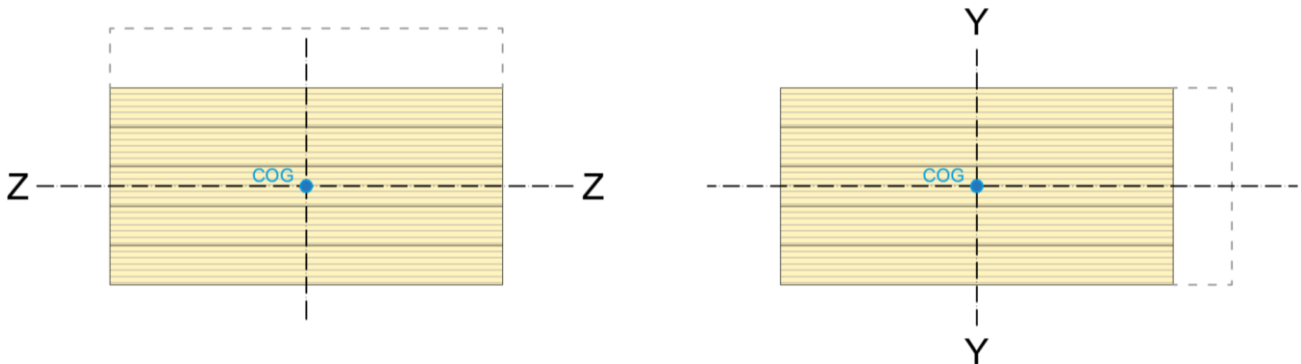

Figure 22: Axis of designation and associated buckling

5.9.4 Lateral torsional buckling (LTB) of LVL G beams subjected to either bending or combined bending and compression

Buckling length:

l_{ef} is the buckling length of the beam, according to the Table 9.

Table 9: Effective length as a ratio of the span

Beam type	Loading type	l_{ef}/l ^a
Simply supported	Constant moment	1,0
	Uniformly distributed load	0,9
	Concentrated force at the middle of the span	0,8
Cantilever	Uniformly distributed load	0,5
	Concentrated force at the free end	0,8

^a The ratio between effective length l_{ef} and the span l is valid for a beam with torsionally restrained supports and loaded at the centre of gravity. If the load is applied at the compression edge of the beam, l_{ef} should be increased by $2h$ and may be decreased by $0.5 h$ for the tension edge of the beam.

If the compressed side of the LVL G member is laterally supported with spacing “a” that may be used as effective length taking account the note in the Table 9 (usually $l_{ef} = a + 2h$).

Condition according to EN1995-1-1 [5], item 6.3.2 (3) needs to be fulfilled. Column stability and lateral torsional stability shall be verified using the characteristic properties $E_{0,k}$. This applies to the LVL G-X as well as to the LVL G-S.

The K_{crit} factor which takes into account the reduced bending strength due to lateral torsional buckling shall be calculated according to EN1995-1-1 [8] (6.3.3).

Lateral torsional stability shall be verified both in the case where only a moment M_d exists about the strong axis and where a combination of moment M_d and compressive force N_c exists.

In the case where a combination of moment M_d about the strong axis and compressive force N_c exists, the stresses should satisfy the following expression according to EN 1995-1-1:

$$\left(\frac{\sigma_{m,d}}{K_{crit} \cdot f_{m,d}} \right)^2 + \frac{\sigma_{c,d}}{K_c \cdot f_{c,0,d}} \leq 1 \tag{Eq 83}$$

In the case where only a moment M_d exists about the strong axis, the stresses should satisfy the following expression:

$$\frac{\sigma_{m,d}}{K_{crit} \cdot f_{m,d}} \leq 1 \tag{Eq 84}$$

where

- $\sigma_{m,d}$ Design bending stress [N/mm²]
- K_{crit} Factor taking into account the reduced bending strength due to lateral torsional buckling
- $f_{m,d}$ Design bending strength [N/mm²]

Factor k_{crit} may be calculated as

$$K_{crit} = \begin{cases} 1 & \text{when } \lambda_{rel,m} < 0.75 \\ 1.56 - 0.75\lambda_{rel,m} & \text{when } 0.75 < \lambda_{rel,m} < 1.4 \\ \frac{1}{\lambda_{rel,m}^2} & \text{when } 1.4 < \lambda_{rel,m} \end{cases} \tag{Eq 85}$$



DESIGN MANUAL

Dec-20

The factor K_{crit} may be taken as 1,0 for a beam where lateral displacement of its compressive edge is prevented throughout its length and where torsional rotation is prevented at its supports.

The relative slenderness ratio may be calculated as

$$\lambda_{rel,m} = \sqrt{\frac{f_{m,k}}{\sigma_{m,crit}}} \quad \text{Eq 86}$$

The critical bending stress may be calculated as

Edgewise LVL G:

$$\sigma_{m,y,crit} = \frac{M_{y,crit}}{W_y} = \frac{\pi \sqrt{E_{0,05,flat} \cdot I_z \cdot G_{0,05} \cdot I_{tor,edge}}}{l_{ef} W_y} \quad \text{Eq 87}$$

Flatwise LVL G:

$$\sigma_{m,z,crit} = \frac{M_{z,crit}}{W_z} = \frac{\pi \sqrt{E_{0,05,edge} \cdot I_y \cdot G_{0,05} \cdot I_{tor,flat}}}{l_{ef} W_z} \quad \text{Eq 88}$$

where

- l_{ef} is the buckling length of the beam, distance between lateral supports [mm];
- $E_{0,05}$ is the fifth percentile value of the modulus of elasticity parallel to the grain [N/mm²];
- I_z is the second moment of inertia about the weak axis z when having an edgewise section [mm⁴];
- I_y is the second moment of inertia about the weak axis y when having a flatwise section [mm⁴];
- $G_{0,05}$ is the fifth percentile value of shear modulus parallel to grain (see note below) [N/mm²];
- I_{tor} is the torsional moment of inertia [mm⁴];

$$I_{tor,edge} = I_{tor,z}$$

$$I_{tor,flat} = I_{tor,y}$$

l_{ef} is the effective length of the beam, depending on the support conditions and the load configuration, according to Table 9 [mm];

W_y is the section modulus about the strong axis y when having an edgewise section [mm³];

W_z is the section modulus about the strong axis z when having a flatwise section [mm³].

Note:

The moment of inertia in the square root is relating to the translator deflection (about weak axis) of the beam. If that beam is then deflecting in a way that the "lay up" is related to the deformation edgewise, then edgewise values shall be used and vice versa.

For the shear modulus: The shear in lateral torsional buckling is relating to St. Venant's Torsion theory and is required, as the wood fibers are shifting against another in torsion in longitudinal direction. For LVL G-X, the shear (shifting) is causing some rolling shear issues. That's why flatwise LVL-X has a lower shear modulus. Since rolling shear failure mechanism is activated in torsion on the LVL-X, the flatwise shear modulus shall be used for both section type in lateral torsional buckling. For LVL G-S, since no rolling shear occurs, the shear modulus according to the respective section type (orientation) can be used ($G_{0,05,flat}$ for flatwise section and $G_{0,05,edge}$ for edgewise section; $G_{0,05,flat}$ being the most conservative).

In Annexe 14.1, a LTB sensitivity analysis can be found.

Torsional moment of inertia for rectangular cross sections:

$$I_{tor,edge} = K_{1,edge} \cdot h \cdot b^3 \quad \text{Eq 89}$$

$$I_{tor,flat} = K_{1,flat} \cdot b \cdot h^3 \quad \text{Eq 90}$$

where $K_1 = 0,12$ for squared cross sections

$$K_{1,edge} = \frac{1}{3} \cdot \left(1 - \frac{0,63 \cdot b}{h}\right) \quad \text{Eq 91}$$

$$K_{1,flat} = \frac{1}{3} \cdot \left(1 - \frac{0,63 \cdot h}{b}\right) \quad \text{Eq 92}$$



storaenso

5.10 Shear parallel to the grain

5.10.1 Flatwise shear strength

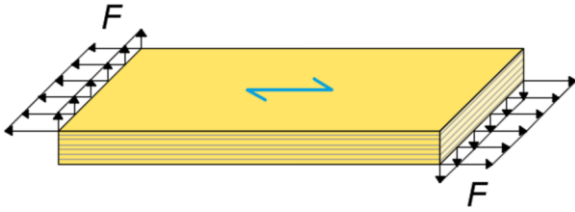

From the characteristic values determined for different tested cross sections, the characteristic flatwise shear strength for different LVL G thicknesses may be determined using the size effect as:

$$f_{v,flatwise,k}(b) = f_{v,flatwise,k}(b_0) \cdot \left(\frac{b_0}{b}\right)^{S_{v,flat}} \quad \text{Eq 93}$$

Where

$f_{v,flatwise,k}$	Characteristic flatwise shear strength of LVL G according to [5]
b	Depth of the LVL G member in flatwise direction
b_0	Reference depth of the LVL G in flatwise direction
$S_{v,flat}$	Size effect factor considering the dependence on the depth b <u>in flatwise direction</u> according to [5]

As written in Table 2 :

$$S_{v,flat,LVL\ G-X} = 0,13$$

LVL G-S

$$f_{(LVL\ G-S)v,0,flatwise,k}(b) = f_{(LVL\ G-S)v,0,flatwise,k}(b_0)$$

$$f_{(GLVL-S)v,0,flatwise,k}(b) = 2,3N/mm^2 \quad \text{Eq 94}$$

Size effect factor is not used for the design of LVL G-S in shear.

$$f_{(LVL\ G-S)v,0,flat,d} = \frac{k_{mod} \cdot f_{(LVL-S)v,0,flat,k}}{\gamma_{m,LVL-S}} \quad \text{Eq 95}$$

$f_{(LVL\ G-S)v,0,flat,d}$ Design shear strength for LVL G-S (flatwise)

k_{mod} Factor, according to EN1995-1-1, Table 3.1, taking a load duration (permanent – very short) and the service class (1-3) into consideration

$f_{(LVL-S)v,0,flat,k}$ Characteristic shear strength of the LVL-S material, according to [5]

$\gamma_{m,LVL-S}$ Partial safety coefficient, applicable for LVL, according to either EN1995-1-1, Table 2.3, or some local regulations.

LVL G-X

$$f_{(LVL\ G-X)v,0,flatwise,k}(b) = f_{(LVL\ G-X)v,0,flatwise,k}(b_0) \cdot \left(\frac{b_0}{b}\right)^{S_{v,flat,LVL\ G-X}}$$

$$f_{(LVL\ G-X)v,0,flatwise,k}(b) = 1,3N/mm^2 \cdot \min \left[1; \left(\frac{90mm}{b}\right)^{0,13} \right] \quad \text{Eq 96}$$

$$f_{(LVL\ G-X)v,0,flat,d} = \frac{k_{mod} \cdot f_{(LVL\ G-X)v,0,flat,k}}{\gamma_{m,LVL-X}} \quad \text{Eq 97}$$



$f_{(LVL\ G-X),v,0,flat,d}$	Design shear strength for LVL G-X (flatwise)
$f_{(LVL\ G-X),v,0,flat,k}$	Characteristic shear strength of the LVL G-X material, according to [5]
$\gamma_{m,LVL-X}$	Partial safety coefficient, applicable for LVL, according to either EN1995-1-1, Table 2.3, or some local regulations.
$k_{vol,v,flat,LVL\ G-X}$	Already included in $f_{(LVL\ G-X),v,0,flat,k}$ with the factor $\left(\frac{90mm}{b}\right)^{0,13}$

5.10.2 Edgewise shear strength

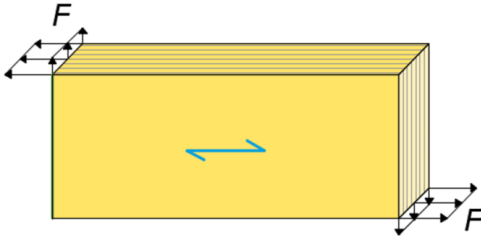

Shear strength for primary LVL may be used in edgewise direction.

LVL G-S

$$f_{v(LVL\ G-S),0,edge,d} = \frac{k_{mod} \cdot k_{cr} \cdot f_{v(LVL-S),0,edge,k}}{\gamma_{M,LVL-S}} \quad Eq\ 98$$

$f_{v(LVL\ G-S),0,edge,d}$	Design shear strength for LVL G-S
k_{mod}	Factor, according to EN1995-1-1 [8], Table 3.1, taking a load duration (permanent – very short) and the service class (1-3) into consideration
k_{cr}	Crack coefficient according to EN 1995-1-1, item 6.1.7 (Consideration for LVL $k_{cr} = 1.0$)
$f_{v(LVL-S),0,edge,k}$	Characteristic shear strength of the LVL-S, according to [3]
$\gamma_{m,LVL-S}$	Partial safety coefficient, applicable for LVL, according to EN1995-1-1, Table 2.3, or local regulations.

LVL G-X

$$f_{v(LVL\ G-X),0,edge,d} = \frac{k_{mod} \cdot k_{cr} \cdot f_{v(LVL-X),0,edge,k}}{\gamma_{M,LVL-X}} \quad Eq\ 99$$

$f_{v(LVL\ G-X),0,edge,d}$	Design shear strength for LVL G-X
k_{mod}	Factor, according to EN1995-1-1 [8], Table 3.1, taking a load duration (permanent – very short) and the service class (1-3) into consideration
k_{cr}	Crack coefficient according to EN 1995-1-1, item 6.1.7 (Consideration for LVL $k_{cr} = 1.0$)
$f_{v(LVL-X),0,edge,k}$	Characteristic shear strength of the LVL-X, according to [3]
$\gamma_{m,LVL-X}$	Partial safety coefficient, applicable for LVL, according to EN1995-1-1, Table 2.3, or local regulations.



5.10.3 Shear stress and verification

Shear stress of the section needs to be checked at the center of gravity COG location as presented in Figure 7 and Figure 23.

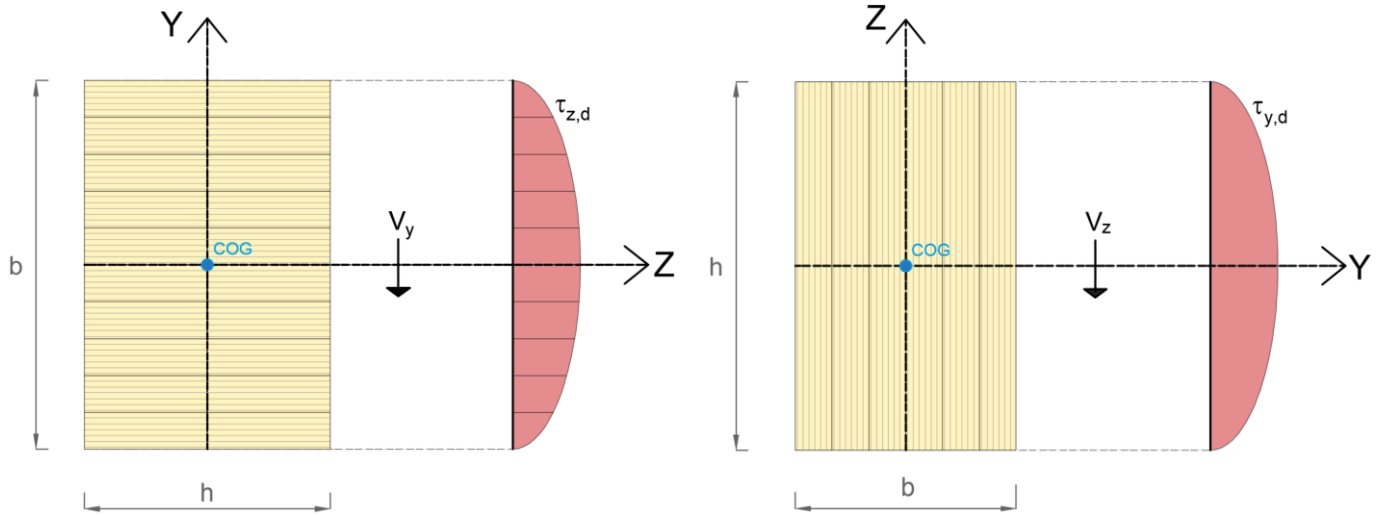

Figure 23: Shear stress depending on the orientation type

Shear stress:

$$\tau_{z(y),d} = \frac{S_{z(y)} \cdot V_{y,d}}{I_z \cdot h} \quad \text{Eq 100}$$

$$\tau_{y(z),d} = \frac{S_{y(z)} \cdot V_{z,d}}{I_y \cdot b} \quad \text{Eq 101}$$

$\tau_{z(y),d}$ Design shear stress at a given coordinate “y” about Z axis [N/mm²] (see Figure 7)
 $\tau_{y(z),d}$ Design shear stress at a given coordinate “z” about Y axis [N/mm²] (see Figure 7)

$S_{z(y)}$ Static moment at the coordinate “y”, about the Z-axis [mm³]
 $S_{y(z)}$ Static moment at the coordinate “z”, about the Y-axis [mm³]

$V_{z,d}$ Design shear force about Z axis [N]
 $V_{y,d}$ Design shear force about Y axis [N]

I_z Effective moment of inertia about the z-axis [mm⁴]
 I_y Effective moment of inertia about the Y-axis [mm⁴]

b Width of the section when having an edgewise section [mm]
 h Width of the section when having a flatwise section [mm]

$$S_{z(y)} = \sum_i A_i \cdot e_{z,i} \quad \text{Eq 102}$$

$$S_{y(z)} = \sum_i A_i \cdot e_{y,i} \quad \text{Eq 103}$$

A_i Area of the partial surface “i” [mm²]
 $e_{z,i}$ Eccentricity of the partial surface “i” = distance between partial C.O.G. of partial surface “i” and the C.O.G. of the entire section about Z axis [mm]
 $e_{y,i}$ Eccentricity of the partial surface “i” = distance between partial C.O.G. of partial surface “i” and the C.O.G. of the entire section about Y axis [mm]

Verification:

$$\tau_{(y)0,d} \leq f_{(LVL\ G),v,0,flat,d} \quad \text{Eq 104}$$

$$\tau_{(z)0,d} \leq f_{(LVL\ G),v,0,edge,d} \quad \text{Eq 105}$$



5.11 Shear perpendicular to the grain

5.11.1 Flatwise shear strength : Rolling shear

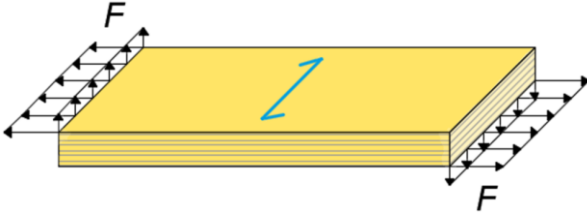

LVL G-X

$$f_{(LVL\ G-X)v,90,flat,d} = k_{mod} \cdot \frac{f_{(LVL-X)v,90,flat,k}}{\gamma_{M,LVL-X}} \quad Eq\ 106$$

$f_{v(LVL\ G-X),90,flat,d}$	Design shear strength for LVL G-X flatwise perpendicular to the grain
k_{mod}	Factor, according to EN1995-1-1 [8], Table 3.1, taking a load duration (permanent – very short) and the service class (1-3) into consideration
$f_{v(LVL-X),90,flat,k}$	Characteristic shear strength of the LVL-X, according to [2]
$\gamma_{M,LVL-X}$	Partial safety coefficient, applicable for LVL, according to EN1995-1-1, Table 2.3, or some local regulations.

5.11.2 Shear stress and verification

The stress calculation has to be carried out in the same way as described in chapter 5.10.3

Shear force in cross direction is

$$V_{Ed,90} = \frac{q_d \cdot s}{2}$$

$V_{Ed,90}$	Design shear force in single span case [kN/m]
q_d	Design load [kN/m ²]
s	Spacing between supports in cross direction [m]

Verification:

$$\tau_{(v)90,d} \leq f_{(LVL\ G),v,90,flat,d} \quad Eq\ 107$$

6. Tapered beams

6.1 Single tapered beams

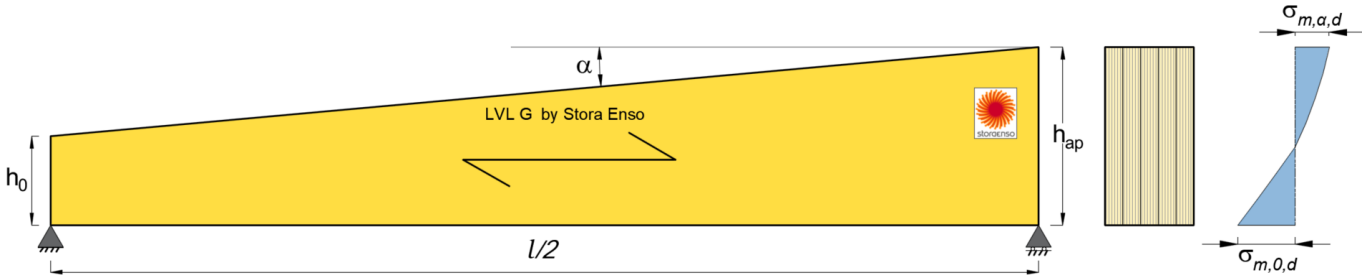

Figure 24: Single-tapered beam. α is the angle between the tapered edge and the grain direction of the beam (EC5 Figure 6.8).

Bending at the critical cross section $h(x)$

For small pitch of the tapered edge, say $\alpha \leq 10^\circ$, which covers the major part of practical cases, the effect of tapering on the bending stress is small. For design purposes, therefore, the maximum bending stress can be calculated as for a beam with constant cross sectional depth (that is $\sigma_{m,0,d} = \frac{M_d}{W}$) both at the tapered edge and at the straight edge. However, the bending strength $f_{m,d}$ is reduced by a reduction factor $k_{m,\alpha}$ at the tapered edge to take into account that shear stress and stress perpendicular to the grain which are acting simultaneously with bending stress at the tapered edge, see Figure 30.

The influence of the taper on the bending stresses parallel to the surface shall be taken into account. The design bending stresses, $\sigma_{m,\alpha,d}$ and $\sigma_{m,0,d}$ may be taken as:

$$\sigma_{m,\alpha,d} = \sigma_{m,0,d} = \frac{6M_d}{bh^2} \quad \text{Eq 108}$$

At the outermost fibre of the tapered edge, the stresses should satisfy the following expression:

$$\sigma_{m,\alpha,d} \leq k_{m,\alpha} \cdot f_{m,d} \quad \text{Eq 109}$$

where

$\sigma_{m,\alpha,d}$ is the design bending stress at an angle to grain [N/mm²];

$\sigma_{m,0,d}$ is the design bending stress at the straight edge [N/mm²];

$f_{m,d}$ is the design bending strength [N/mm²];

h is the corresponding depth of the beam at the critical section at the position of maximum bending stress [mm];

$k_{m,\alpha}$ is the factor for combined stresses in tapered beams calculated as follows:

For tensile stresses parallel to the tapered edge:

$$k_{m,\alpha} = \frac{1}{1 + \left(\frac{f_{m,d}}{a \cdot f_{v,d}} \tan \alpha\right)^2 + \left(\frac{f_{m,d}}{f_{t,90,d}} \tan^2 \alpha\right)^2} \quad \text{Eq 110}$$

Where

$$a = \begin{cases} 0,75 & \text{for LVL - S} \\ 1,0 & \text{for LVL - X} \end{cases}$$

For compressive stresses parallel to the tapered edge:

$$k_{m,\alpha} = \frac{1}{1 + \left(\frac{f_{m,d}}{b \cdot f_{v,d}} \tan \alpha\right)^2 + \left(\frac{f_{m,d}}{f_{c,90,d}} \tan^2 \alpha\right)^2} \quad \text{Eq 111}$$

where

$$b = \begin{cases} 1,5 & \text{for LVL - S} \\ 1,0 & \text{for LVL - X} \end{cases}$$



It is not necessary to take $k_{m,\alpha}$ into consideration in the resistance against lateral torsional buckling of the beam as written in Eq 84. The effects of combined axial force and bending moment shall be taken into account.

Table 10: Strength reduction factor $K_{m,\alpha}$ for tensile and compressive stress parallel to the tapered edge

$K_{m,\alpha}$	Stress parallel to tapered edge	Angle α									
		0	5 °	10 °	15 °	20 °	25 °	30 °	35 °	40 °	45 °
LVL G -S	Tapered edge in tension	1,00	0,60	0,31	0,18	0,11	0,07	0,05	0,03	0,02	0,02
LVL G -X		1,00	0,85	0,62	0,45	0,34	0,27	0,21	0,17	0,13	0,10
LVL G -S	Tapered edge in compression	1,00	0,85	0,62	0,45	0,34	0,26	0,20	0,16	0,13	0,10
LVL G -X		1,00	0,85	0,62	0,46	0,36	0,28	0,23	0,19	0,15	0,12

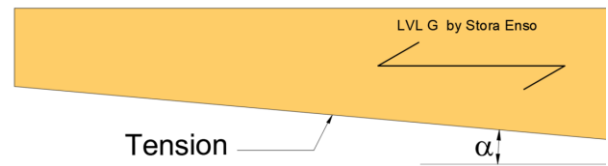
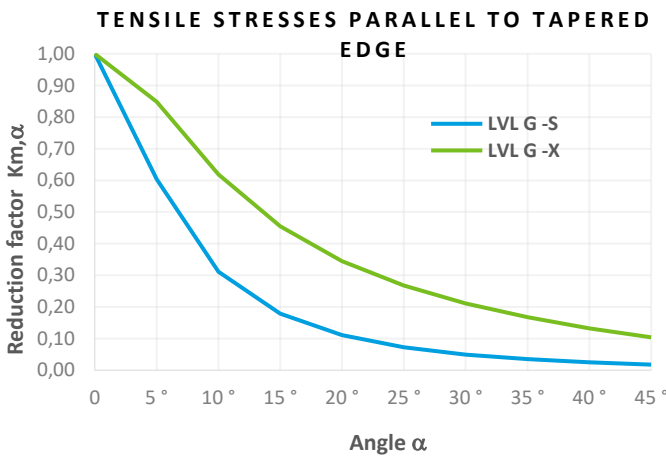

Figure 25: Strength reduction factor $K_{m,\alpha}$ for tensile stress parallel to the tapered edge

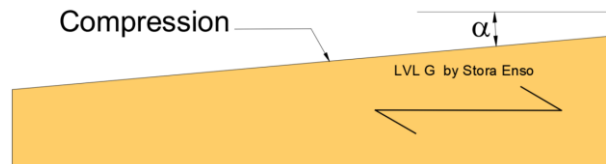
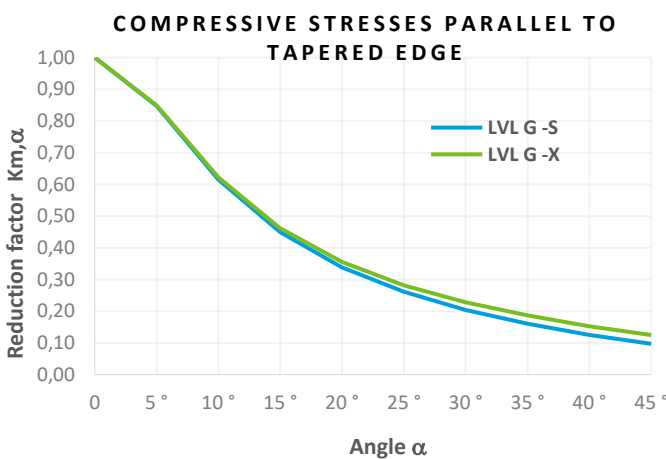

Figure 26: Strength reduction factor $K_{m,\alpha}$ for compressive stress parallel to the tapered edge

Tensile stresses perpendicular to the grain form at a tapered tensile edge and compressive stresses perpendicular to the grain at a tapered compressive edge. As a general rule, cut wood fibres should preferably be arranged in the compression zone of beams, so that the lamellae run parallel to the beam edge in the tensile zone.

When the tapered edge is under tension stress, $k_{m,\alpha}$ is used to reduce the bending strength in the equations for combined stresses as written in Eq 68 and Eq 69.



DESIGN MANUAL

Dec-20

When the tapered edge is under compression stress, $k_{m,\alpha}$ is used to reduce the bending strength in the equations for combined stresses as written in Eq 66 and Eq 67.

Since both the moment and the depth vary along the axis of the beam, maximum bending stress as a rule occurs not where the moment is greatest but at a section nearer the supports. The position of this section can be determined analytically from the condition:

$$\frac{d\sigma(x)}{dx} = \frac{d}{dx} \left(\frac{M(x)}{W(x)} \right) = 0 \tag{Eq 112}$$

For simply supported single tapered beams or symmetrical double tapered beams with uniformly distributed loads, the critical section is at the distance:

$$x = \frac{h_0}{2 \cdot h_{ap}} \cdot l \tag{Eq 113}$$

x from the support, where h_0 is the depth of the beam at the support and h_{ap} is the maximum beam depth.

The corresponding depth of the beam (critical section) is:

$$h(x) = h_0 + x \cdot \tan \alpha \tag{Eq 114}$$

The distribution of bending stresses in tapered beams is non-linear already due to the beam geometry, since the slope of the beam edge results in additional shear stresses τ and stresses perpendicular to the grain σ_{90} .

For small angles of inclination, α up to around $\alpha \leq 10$, however, this non-linearity is small. Accordingly, the bending stresses in the outer fibres and shear stress can be determined more simplistically in accordance with the Euler-Bernoulli beam theory.

Moreover, for such beams the highest shear stress is in general not at the neutral axis. The location of maximum shear stress is, in fact, closer to the tapered edge (see Figure 27 and Figure 29).

The strength of the beam in Figure 27 must hence be verified in two cross-sections: in cross-section h_0 , in which the shear stresses peak and cross-section $h(x)$, in which the bending stresses peak.

For high pitched roof beams ($\alpha \geq \sim 10^\circ$) the maximum shear stress $\tau_{max,d}$ and tension perpendicular to the grain $\sigma_{90,max,d}$ shall be calculated at the point of the maximum bending moment stress with the equations:

$$\tau_{v,max,d} = \sigma_{m,0,max,d} \cdot \tan \alpha \tag{Eq 115}$$

$$\sigma_{90,max,d} = \sigma_{m,0,max,d} \cdot \tan^2 \alpha \tag{Eq 116}$$

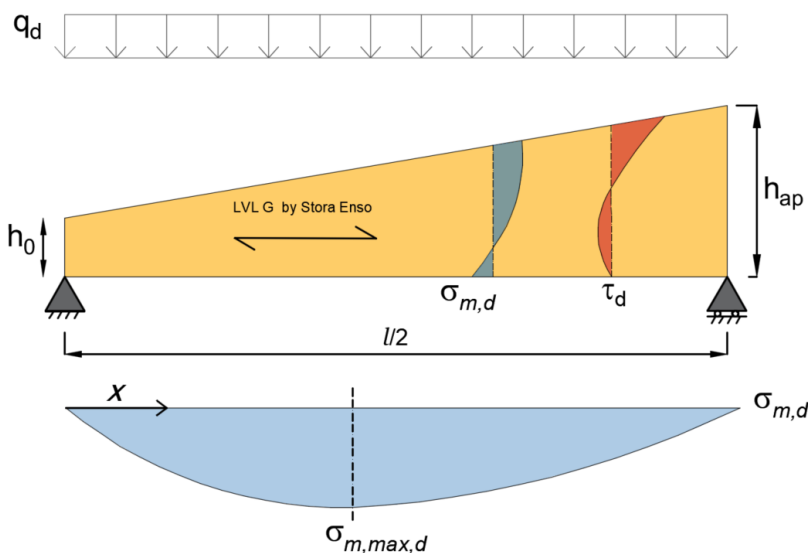

Figure 27: Stress distributions in single tapered beams

It is recommended to have the tapered edge on the compressive side, especially for LVL G-S, since the tension perpendicular to grain strength $f_{t,90,edge,k}$ is low, which can lead to cracks and brittle failure.

LVL G-X may be used for special shapes, also when the tapered edge is on the tensile side, as its $f_{t,90,edge,k}$ is higher due to the cross veneers and it behaves more ductile.

Tension perpendicular to grain should therefore be kept as low as possible.

In addition, shear stress and compression perpendicular to the grain at the supports must be verified in cross-section h_0 .



storaenso

6.2 Double tapered beams

For double-tapered beams, the requirements for single tapered beams apply to the parts of the beam which have a single taper and design instruction are given in EN1995-1-1 clause 6.4.3 with the additional information:

- Factor $K_r = 1$ for LVL in the edgewise direction, as the shape of the beam is cut directly from a panel and no reduction due to bending of the laminates during production is needed.
- $K_{m,\alpha}$ is not used together with the equations for checking the stresses at the apex zone.
- It is not necessary to take K_l into consideration in the resistance against lateral torsional buckling of the beam (Eq 84), it is used only for bending in the apex zone.

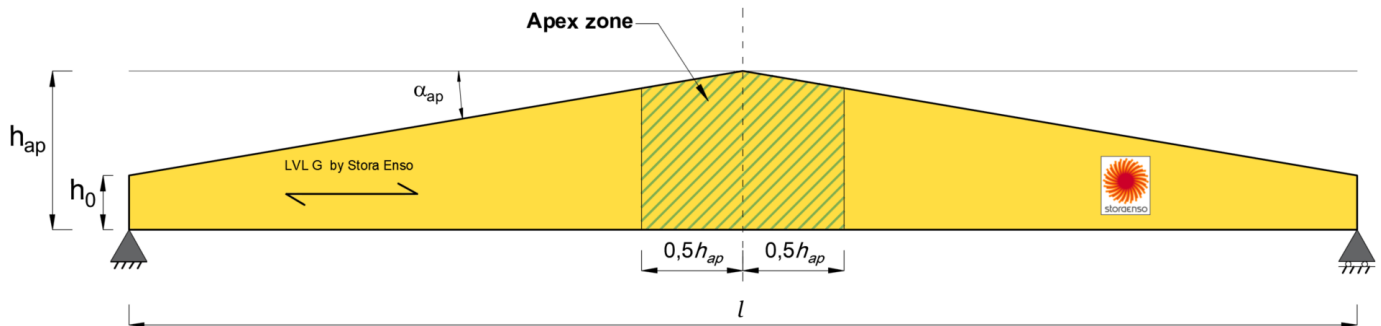

Figure 28: Apex zone of double tapered beam

Bending at the critical cross section $h(x)$

See chapter 6.1 Single tapered beams.

Bending stress in the apex zone

The bending stress in the apex zone must also be checked, even though it seldom governs the design. In the apex zone of double tapered beams, the bending stress distribution is complex and non-linear. The bending stress at the apex will be zero and the bending stress distribution will be as shown in Figure 29.

In the apex zone (see Figure 28), the tensile bending stress shall be magnified by a factor K_l to take into account of the fact that the depth of the beam is not constant, but varies linearly and has a singularity at the apex.

The bending stress is calculated according to the following expression:

$$\sigma_{m,d} = K_l \cdot \frac{M_{ap,d}}{W_{ap}} = K_l \cdot \frac{6 \cdot M_{ap,d}}{b h_{ap}^2} \quad \text{Eq 117}$$

$$K_l = K_1 + K_2 \left(\frac{h_{ap}}{r} \right) + K_3 \left(\frac{h_{ap}}{r} \right)^2 + K_4 \left(\frac{h_{ap}}{r} \right)^3 \quad \text{Eq 118}$$

$r = \infty$ in double tapered beam $\rightarrow K_l = K_1$

where

K_l is a factor determined by finite element analysis that takes into account the tapering of laminations. The magnification factor K_l increases with increasing roof slope and it can be obtained from EN1995-1-1 clause 6.4.3 .

$M_{ap,d}$ is the design moment at the apex [N.mm]

b is the LVL G beam width [mm]

h_{ap} is the LVL G beam height of the section at the apex [mm]

W_{ap} is the section modulus of the beam at the apex [mm³].

According to EN1995-1-1, the stresses should satisfy the following expression:

$$\sigma_{m,d} \leq f_{LVL G, m, 0, edge, d} \quad \text{Eq 119}$$



Tensile stress perpendicular to the grain in the apex zone

In the apex zone, the greatest tensile stress perpendicular to the grain $\sigma_{t,90,d}$ due to bending moment is calculated according to the following expression:

$$\sigma_{t,90,d} = K_p \cdot \frac{M_{ap,d}}{W_{ap}} = K_p \cdot \frac{6 \cdot M_{ap,d}}{bh_{ap}^2} \quad \text{Eq 120}$$

When designing double-tapered beams, it is crucial to take a volume and stress distribution effect in the apex zone into consideration, since this is where, based on geometry, high tensile stresses perpendicular to the grain frequently occur with a simultaneous large volume.

The design tensile strength perpendicular to the grain must be reduced to take into account the volume effect. According to EN1995-1-1, the stresses should satisfy the following expression:

$$\sigma_{t,90,d} \leq K_{dis} \cdot K_{vol} \cdot f_{t,90,edge,d} \leq K_{dis} \cdot \left(\frac{0,01}{V}\right)^{0,2} \cdot f_{t,90,edge,d} \quad \text{Eq 121}$$

where

K_p is a factor determined by finite element analysis, defined as the ratio between perpendicular to grain stress and bending stress at the apex (can be calculated according to EN1995-1-1 clause 6.4.3).

$$K_p = K_5 + K_6 \left(\frac{h_{ap}}{r}\right) + K_7 \left(\frac{h_{ap}}{r}\right)^2$$

K_{dis} is a factor which takes into account the effect of the stress distribution in the apex zone $K_{dis} = 1,4$ for double tapered beams;

$K_{vol} = \left(\frac{V_0}{V}\right)^{0,2}$ is a volume factor; with all veneers parallel to the beam axis

V_0 is the reference volume of 0,01m³;

V is the stressed volume of the apex zone subject to tension perpendicular to the grain, in m³ (see Figure 28) and should not be taken greater than $\frac{2 \cdot V_b}{3}$ where V_b is the total volume of the beam.

$f_{t,90,edge,d}$ is the design tensile strength perpendicular to the grain;

For combined tension perpendicular to grain and shear stresses according to EN1995-1-1, a combined verification is performed with linear stress interaction and should satisfy the following expression:

$$\frac{\tau_{(z),d}}{f_{v,0,edge,d}} + \frac{\sigma_{t,90,d}}{K_{dis} \cdot K_{vol} \cdot f_{t,90,edge,d}} \leq 1 \quad \text{Eq 122}$$

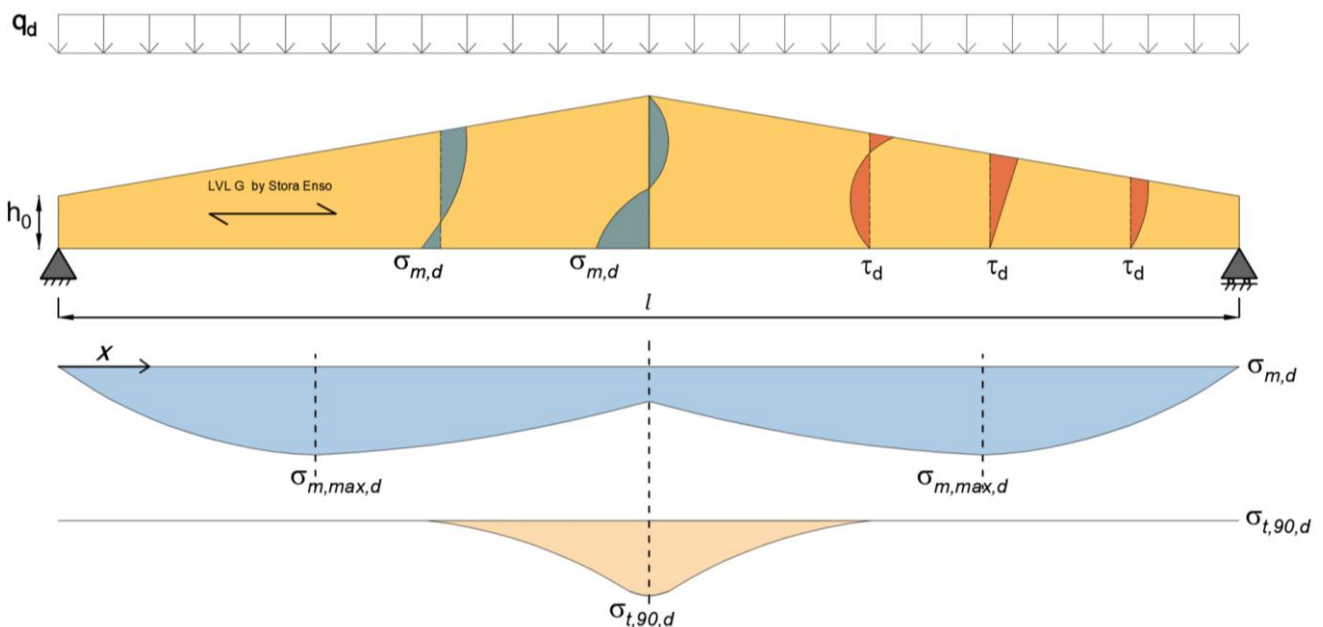

Figure 29: Stress distributions in double tapered beams



In addition, shear stress and compression perpendicular to the grain at the supports must be verified in cross-section h_0 .

When the angle between loading and the grain is large ($\alpha \geq 10^\circ$), shear stress at the point of maximum bending moment stress may become more critical than the shear stress at the support.

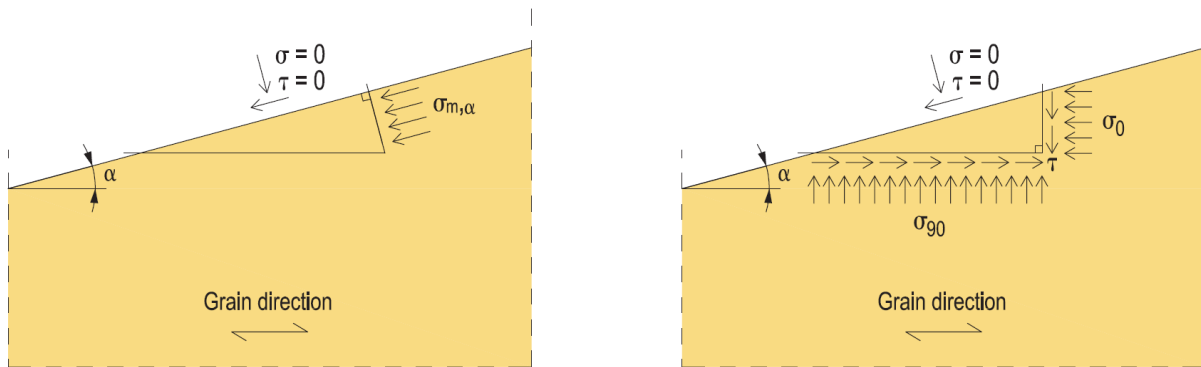

Figure 30: Stresses at the tapered edge of a beam: bending stress $\sigma_{m,\alpha}$ at the direction of the edge, bending stress at the grain direction σ_0 and shear stress $\tau_v = \sigma_0 \cdot \tan \alpha$ and stress perpendicular to the grain $\sigma_{90} = \sigma_0 \cdot \tan^2 \alpha$.

As shown in Figure 30, close to the tapered edge there are both stresses perpendicular to the grain σ_{90} and shear stresses parallel to the grain τ additionally to the axial stresses. The magnitude of such stresses increases with increasing slope of the tapered edge.

Knowing the stress component $\sigma_{m,\alpha}$ parallel to the tapered edge (Figure 30, left), the stress acting on the planes parallel to the grain and perpendicular to the grain respectively (Figure 30, right) for uniaxial tension under an angle α to the 1-axis, can be calculated from the equation of statics:

$$\sigma_0 = \sigma_{m,\alpha} \cdot \cos^2 \alpha \tag{Eq 123}$$

$$\sigma_{90} = \sigma_{m,\alpha} \cdot \sin^2 \alpha = \sigma_0 \cdot \tan^2 \alpha \tag{Eq 124}$$

$$\tau = \sigma_0 \cdot \tan \alpha = \sigma_{m,\alpha} \cdot \sin \alpha \cdot \cos \alpha \tag{Eq 125}$$

(see equation derivation in Annexe 14.3)

In situations where the design tensile strength for stresses perpendicular to the grain is exceeded, mechanical fastenings such as glued-in rods or fully-threaded screws may be used as reinforcement.

6.2.1 Climate action on double-tapered beams

The specified tensile stress verifications perpendicular to the grain (Eq 121 and Eq 122) for the apex zone of double-tapered beams only apply for non-reinforced beams. All verifications are performed with design loads; stresses due to swelling and shrinking processes, which, in turn, are triggered by climatic fluctuations are not taken into consideration.

However, the beam shape is very vulnerable to tensile stresses perpendicular to the grain, which may also be triggered by climate change and which may cause additional strain on the beams, additionally to the pre-existing external forces.

Accordingly, it's recommended that such beams should be reinforced to take into account the additional climate-related tensile stresses perpendicular to the grain.

According to the relevant national annex, double-tapered beams should be reinforced from a limit utilisation rate % (80% in Germany) in equations Eq 121 and Eq 122.

In situations where the design tensile strength for stresses perpendicular to the grain is exceeded, mechanical fastenings such as glued-in rods or full-threaded screws may be used as reinforcement.



7. Notched beams

The effects of stress concentrations at the notch shall be taken into account in the strength verification of members according to EN1995-1-1 chapter 6.5.2 . The effect of stress concentrations may be disregarded in the following cases:

- Tension or compression parallel to the grain;
- Bending with tensile stresses at the notch, if the taper is not steeper than 1:i = 1:10, that is $i \geq 10$, see Figure 31)
- Bending with compressive stresses at the notch, see Figure 31 B)

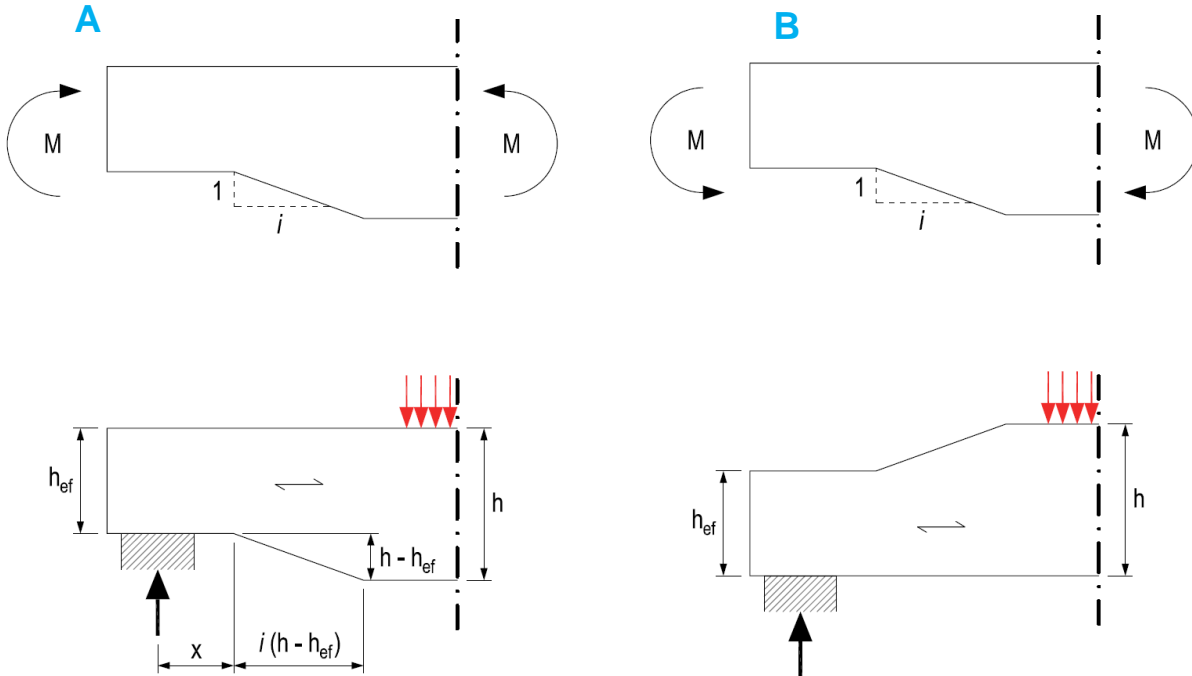

Figure 31: Bending at a notch A) with tensile stresses at the notch B) with compressive stresses at the notch (EC5 Figure 6.10 and 6.11).

When the taper at the notch at tensile side is steeper than 1:10, it can be located only at the support. For beams with rectangular cross sections and where the grain runs essentially parallel to the length of the member, the shear stresses at the notched support should be calculated using the effective (reduced) depth h_{ef} , see Figure 31). It should be verified that

$$\tau_d = \frac{1,5 \cdot V_d}{b \cdot h_{ef}} \leq k_v \cdot f_{v,0,edge,d} \quad \text{Eq 126}$$

Where K_v is a reduction factor defined as follows:

- For beams notched at the opposite side to the support, see Figure 31 B), $K_v = 1$
- For beams notched on the same side as the support, see Figure 31 A)

$$K_v = \min \left(1; \frac{K_n \cdot \left(1 + \frac{1,1 \cdot i^{1,5}}{\sqrt{h}} \right)}{\sqrt{h} \cdot \left(\sqrt{\alpha} \cdot (1 - \alpha) \right) + 0,8 \cdot \frac{x}{h} \cdot \sqrt{\frac{1}{\alpha} - \alpha^2}} \right) \quad \text{Eq 127}$$

where

- i is the notch inclination (for rectangular notches $i = 0$);
- h is the beam depth in [mm];
- x is the distance from line of action of the support reaction to the corner of the notch [mm];



$$\alpha = \frac{h_{ef}}{h}$$

Eq 128

$K_{n,edge} = 4,5$ for LVL in general

(Although it is written in EC5 that $K_n = 4,5$ for LVL in general, that value has not been determined in flatwise direction yet. The $K_{n,lat}$ factor will be determined by means of testing and will be integrated in the future version of EN1995-1-1. Therefore it is currently valid only for notches in edgewise direction).

At supports, the contribution to the total shear force of a concentrated load F acting on top side of the beam and within a distance h or h_{ef} from the edge of the support may be disregarded. For beams with notches, at the supports, this reduction in the shear force applies only when the notch is on the opposite side to the support. For uniformly distributed loads, the determining shear force maybe taken at a distance of the member h from the support.

Maximum design shear force capacity V_d is given by:

$$V_d \leq \frac{k_V \cdot f_{v,0,edge,d} \cdot b \cdot h_{ef}}{1,5}$$

Eq 129

8. Holes in edgewise beams

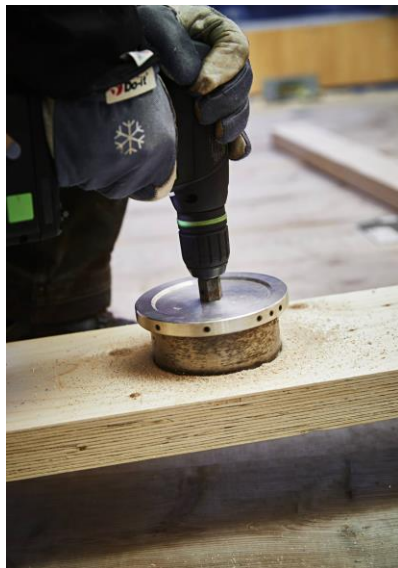

Holes are openings with a clear dimension $d \geq h/10$ with h , being the height of the beam or $d \geq 80\text{mm}$.

According to ÖNORM B 1995-1-1:2015 [8] the application of unreinforced circular and rectangular holes is restricted to service class 1 and 2.

In general, it is not allowed to carry out on the building site openings not planned in design.

Until more specific rules are determined for Stora Enso LVL by experimental tests, relevant rules for reinforced holes (and notches) can be found in National Annexes to EN 1995-1-1 (e. g. ÖNORM B 1995-1-1).

8.1 Geometric boundary conditions

In the current European standard for the design of timber structures EN 1995-1-1 [12] no explicit rules for the verification of holes in beams (loaded in bending) are given. Nevertheless, rules for the handling of this important topic are defined in a few National Annexes of the mentioned standard.

In Figure 32 and Figure 33, the geometric boundary conditions regarding holes in beams are shown.

The rules given in the further sections of this chapter are only valid if the following geometric boundary conditions are respected.

General boundary condition :

- $l_V \geq h$
- $l_A \geq 0.5 \cdot h$



Additionally for circular holes :

- $h_d = d \leq 0.7 \cdot h$
- When the hole centre is situated at neutral axis:
 $h_{ro} \geq 0.15 \cdot h$ and $h_{ru} \geq 0.15 \cdot h$
- When the hole centre is situated eccentrically to the neutral axis (eccentricity) :
 $h_{ro} \geq 0.25 \cdot h$ and $h_{ru} \geq 0.25 \cdot h$
- $l_z \geq \max \left\{ \frac{1.00 \cdot h}{2 \cdot d} \right.$

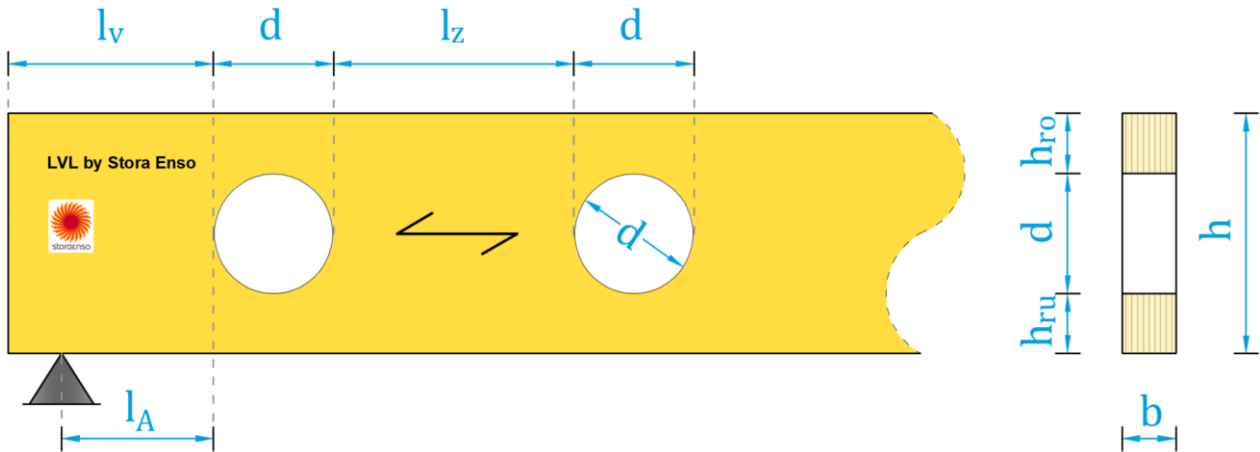

Figure 32: Definitions of geometric dimensions related to circular holes

Additionally for rectangular holes: The radius of curvature at each corner shall be at least 15 mm.

- $h_d \leq 0.3 \cdot h$ for LVL G-S ; $h_d \leq 0.4 \cdot h$ for LVL G-X
- $a \leq 1.5 \cdot h$
- $h_{ro} \geq 0.35 \cdot h$ and $h_{ru} \geq 0.35 \cdot h$ for LVL G-S ; $h_{ro} \geq 0.30 \cdot h$ and $h_{ru} \geq 0.30 \cdot h$ for LVL G-X
- $l_z \geq 1.5 \cdot h$

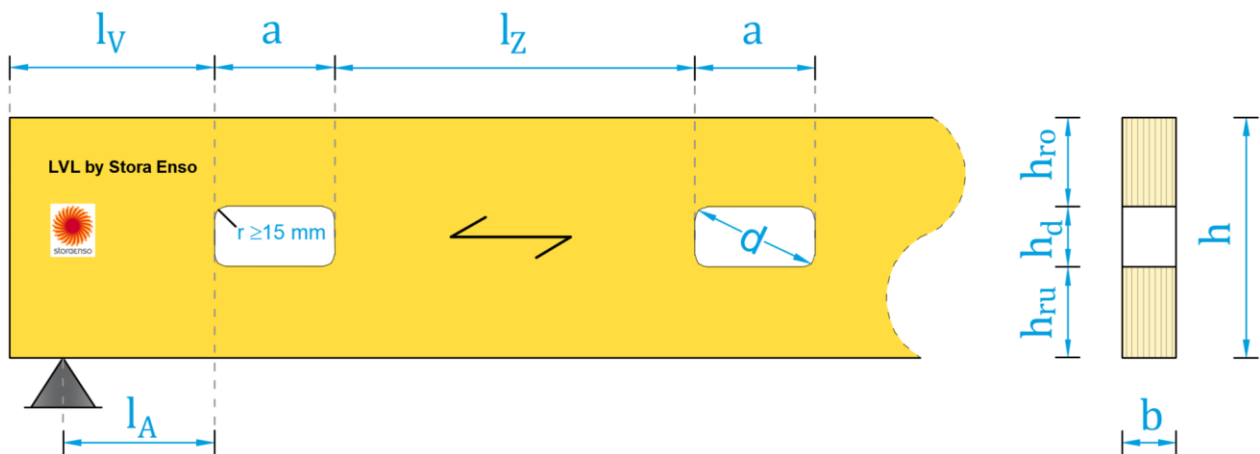

Figure 33: Definitions related to rectangular holes.

- h Depth of the beam [mm] ;
- h_d Diameter or height of the opening [mm] ;
- l_z Distance between two holes [mm];
- a Length of the rectangular opening [mm]; for circular holes $a = h_d$.



8.2 Size and location of the holes

- Beams with circular holes (LVL G-S and LVL G-X) loaded in bending

Geometrical limitations for circular holes in LVL-S and LVL-X by Stora Enso beams.

BEAM HEIGHT	MIN DISTANCE FROM THE BEAM END	MIN DISTANCE FROM THE SUPPORT	MIN DISTANCE BETWEEN HOLES	Center of the hole on neutral axis		Center of the hole not on neutral axis	
				MAXIMUM DIAMETER OF THE HOLE	DISTANCE FROM THE EDGES OF THE BEAM	MAXIMUM DIAMETER OF THE HOLE	DISTANCE FROM THE EDGES OF THE BEAM
h [mm]	L _v min [mm]	L _A min [mm]	L _z min [mm]	d [mm]	h _{ro} and h _{ru} min [mm]	d [mm]	h _{ro} and h _{ru} min [mm]
200	200	100	280	140	30	100	50
240	240	120	336	168	36	120	60
300	300	150	420	210	45	150	75
350	350	175	490	245	52,5	175	87,5
400	400	200	560	280	60	200	100
450	450	225	630	315	67,5	225	112,5
500	500	250	700	350	75	250	125
600	600	300	840	420	90	300	150

- Beams with rectangular holes (LVL G-S and LVL G-X) loaded in bending

Geometrical limitations for rectangular holes in LVL-S and LVL-X by Stora Enso beams.

BEAM HEIGHT	MIN DISTANCE FROM THE BEAM END	MIN DISTANCE FROM THE SUPPORT	MIN DISTANCE BETWEEN HOLES	MAXIMUM LENGTH OF TWO HOLE	MAXIMUM HEIGHT OF THE HOLE	DISTANCE FROM THE EDGES OF THE BEAM
h [mm]	L _v min [mm]	L _A min [mm]	L _z min [mm]	a max [mm]	h _d max [mm]	h _{ro} and h _{ru} min [mm]
200	200	100	300	300	60 (S) / 80 (X)	70 (S) / 60 (X)
240	240	120	360	360	72 (S) / 96 (X)	84 (S) / 72 (X)
300	300	150	450	450	90 (S) / 120 (X)	105 (S) / 90 (X)
350	350	175	525	525	105 (S) / 140 (X)	122,5 (S) / 105 (X)
400	400	200	600	600	120 (S) / 160 (X)	140 (S) / 120 (X)
450	450	225	675	675	135 (S) / 180 (X)	157,5 (S) / 135 (X)
500	500	250	750	750	150 (S) / 200 (X)	175 (S) / 150 (X)
600	600	300	900	900	180 (S) / 240 (X)	210 (S) / 180 (X)

As a conservative approach in the design of unreinforced holes the initiation of the first crack is recommended to be considered as the “ultimate” load and stress level accordingly. The difference between the load level at the occurrence of the 1st crack and the maximum load has to be seen as a “buffer” for the missing interaction of stresses (e. g. simultaneously acting stresses due to tensile stresses perpendicular to the grain and shear stresses) as well



as loading effects from temperature and moisture content (shrinkage / swelling) in the vicinity of the hole not considered explicitly in the verification.

The following equations and design steps for unreinforced holes are based on the report from holz.bau forschungs gmbh [14]. The equations for the determination of the shear factor k_τ considering the stress concentrations at the contour of the circular and rectangular openings shall be used. This method is also based on a multitude of tests on LVL beams by Stora Enso with openings [15]. This includes alternatives to the method in the standard [16] for the verification of the tensile stresses perpendicular to grain which makes it possible to justify bigger ratios $\frac{h_d}{h}$ as given there.

Approach of Ardalany

The underlying mechanical model is based on a beam on elastic foundation assuming that the lower part of the cracked beam is infinitely stiff in bending according to the approach of Ardalany [14].

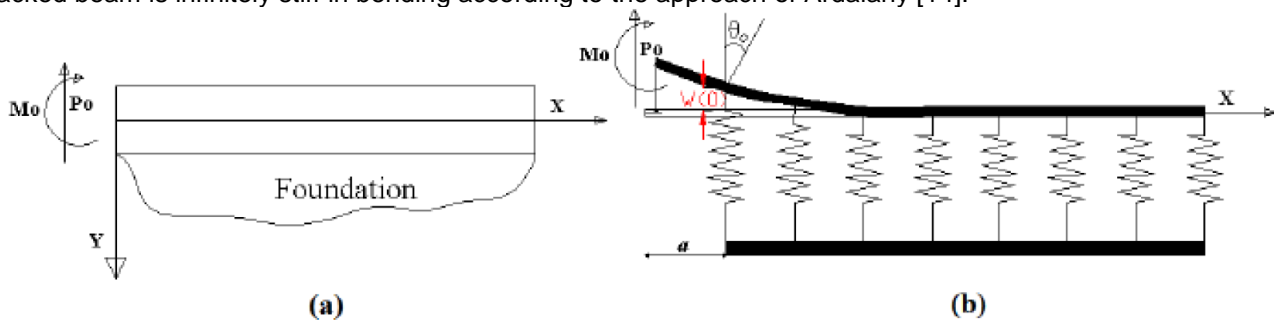

Figure 34 : Model of beam on elastic foundation: (a) beam on elastic foundation, (b) schematization of a beam on springs as elastic foundation, [20].

8.3 Verification of the tension perpendicular to grain (approach of Ardalany)

8.3.1 due to pure shear

The tension force perpendicular to grain for loadings in pure shear can be computed as follows:

$$F_{cr,t,90,V} = \frac{b \cdot f_{t,90}}{\sqrt{4 \cdot \lambda^2 + \frac{6}{5} \cdot \frac{K \cdot b}{G \cdot A}}} \quad \text{Eq 130}$$

With

$$\lambda = \sqrt[4]{\frac{K \cdot b}{4 \cdot E \cdot I}} \quad \text{Eq 131}$$

$$K = \frac{1}{2} \cdot \frac{f_{t,90}^2}{G_{I,f}} \quad \text{Eq 132}$$

The total shear resistance of the hole is twice this force as follows:

$$F_{cr,V} = 2 \cdot F_{cr,t,90,V} \quad \text{Eq 133}$$

$F_{cr,t,90,V}$	Shear resistance of the beam section for pure shear (at crack initiation), splitting force [N];
$F_{cr,V}$	Total shear resistance of the beam section for pure shear [N] ;
K	Spring stiffness in a beam on elastic foundation [N/mm ³] ;
$G_{I,f}$	Fracture energy in mode I (opening) [N/mm] (see chapter 8.3.4);
$f_{t,90}$	Tensile strength perpendicular to grain [N/mm ²];
b	Width of the beam [mm] ;
E	Modulus of elasticity [N/mm ²] ;



I	Moment of the inertia $I = \frac{b \cdot h_{cr}^3}{12}$ [mm ⁴];
h_{cr}	Height of a portion of a beam above potential crack surface [mm]; <u>For circular opening</u> : $h_{cr} = \frac{h}{2} - \frac{h_d}{2} \cdot \cos \alpha$, with $\alpha = 45^\circ$ <u>For rectangular opening</u> : $h_{cr} = \frac{h}{2} - \frac{h_d}{2}$
λ	Parameter in beam on an elastic foundation theory [1/mm];
G	Shear modulus of the beam section [N/mm ²];
A	Shear area ($A = b \cdot h_{cr}$).

8.3.2 due to pure bending

With the denotations used in standards , the local moment in the upper part of the beam on elastic foundation at crack initiation is as follows:

$$M_{cr,t,90} = \frac{b}{2 \cdot \lambda^2} \cdot f_{t,90} \quad \text{Eq 134}$$

The total moment is composed two parts:

a. Constant (rectangular) stress distribution

$$\sigma_N = \sigma_M \cdot \frac{h_{cr} + h_d \cdot \cos \alpha}{h_{cr}} \quad \text{Eq 135}$$

with the resultant compression force

$$N = b \cdot \sigma_M \cdot (h_{cr} + h_d \cdot \cos \alpha) \quad \text{Eq 136}$$

b. Triangular stress distribution

The triangular stresses are given by:

$$\sigma_{cr,t,90,M} = \frac{M_{cr,t,90}}{W} \quad \text{Eq 137}$$

Considering the moment of both portions of the beam (upper and lower portion) as well as from the resultant axial forces the total moment is given. Due to the different lever arm of circular and rectangular holes it is given by:

- for circular holes: Eq 138

$$M_{cr,M} = 2 \cdot M_{cr,t,90} + b \cdot \sigma_{cr,t,90,M} \cdot (h_{cr} + h_d \cdot \cos \alpha) \cdot (h - h_{cr})$$

- for rectangular holes: Eq 139

$$M_{cr,M} = 2 \cdot M_{cr,t,90} + b \cdot \sigma_{cr,t,90,M} \cdot (h_{cr} + h_d) \cdot (h - h_{cr})$$

where

b	Width of the beam [mm];
W	Cross section modulus $W = \frac{b \cdot h_{cr}^2}{6}$ [mm ³];
h_{cr}	Height of a portion of a beam above potential crack surface [mm];
$\sigma_{cr,t,90,M}$	Stress due to bending moment [N/mm ²];
$M_{cr,t,90}$	Moment resistance of the section [N·mm];
$M_{cr,M}$	Total resistance moment of the beam section for pure bending [N·mm].



8.3.3 Beam subjected to combined shear and bending moment (Splitting)

In general combined actions form shear and bending moment occur in the beam. Thus an interaction equation has to be taken into account. The following empirical relationship shall be fulfilled:

$$\left(\frac{V_{cr}}{F_{cr,V}}\right) + \left(\frac{M_{cr}}{M_{cr,M}}\right)^2 = 1 \quad \text{Eq 140}$$

where

M_{cr} Design bending moment [N·mm] ;
 V_{cr} Design shear force at the location of the hole [N].

8.3.4 Fracture energy rate $G_{I,f}$ in mode I (opening)

The determination of the fracture energy rate $G_{I,f}$ described in [17] is based on test configuration of CIB-W18 standard draft proposed by Larsen and Gustafsson [21].

The experimentally determined values for LVL by Stora Enso are:

Mean value: $G_{I,f,mean} = 0.875 \text{ N/mm}$

Characteristic value: $G_{I,f,k} = 0.625 \text{ N/mm}$

Since the fracture energy value $G_{I,f}$ is a material parameter used in ULS verification, the modification factor K_{mod} (considering the moisture content and duration of load of the members) as well as a partial safety factor γ_M have to be considered for the computation of the design value $G_{I,f,d}$.

$$G_{I,f,d} = \frac{k_{mod} \cdot G_{I,f,k}}{\gamma_m} \quad \text{Eq 141}$$

8.4 Verification of shear stresses for circular and rectangular holes in beams

In addition to the tensile stresses at the circumference (contour) of the hole also the shear stresses have to be verified in the design steps. In a first approximation these stresses can be determined applying the equation from the Beam Theory for the net cross section, but it is obvious that due to the redistribution of stresses in the vicinity of the hole stress peaks will occur at the corners.

By considering these concentration peaks in the design, the maximum shear stress at the contour of the hole can be multiplied by the factor for the shear stresses k_τ applicable for circular and rectangular holes.

The shear stress at the hole location should satisfy the following expression:

$$\tau_d = k_\tau \cdot 1,5 \cdot \frac{V_d}{b \cdot (h - h_d)} \leq f_{v,d} \quad \text{Eq 142}$$

Since the redirection of stresses is expected to be more smooth for circular holes and thus lead to minor pronounced stress peak at the contour of the hole, a different k_τ factor shall be applied for each shape.

The following equations were determined by means of linear elastic FEM-simulations and shall be applied:



Rectangular holes

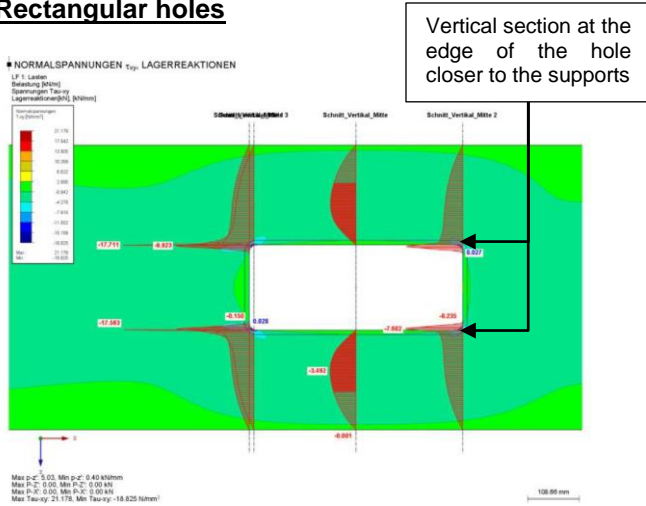

Figure 35: Shear stress distribution at the contour of a rectangular hole

For the computation of the maximum shear stresses, the shear factor k_τ at the corners of rectangular holes shall be determined according to [17] and [19], as follows:

$$k_\tau = 1,85 \cdot \left(1 + \frac{a}{h}\right) \cdot \left(\frac{h_d}{h}\right)^{0,2} \quad \text{Eq 143}$$

With : $0.1 \leq \frac{a}{h} \leq 1.0$ and $0.1 \leq \frac{h_d}{h} \leq 0.4$

The maximum shear stress value should be determined in the vertical section at the edge of the hole closer to the supports.

Circular holes

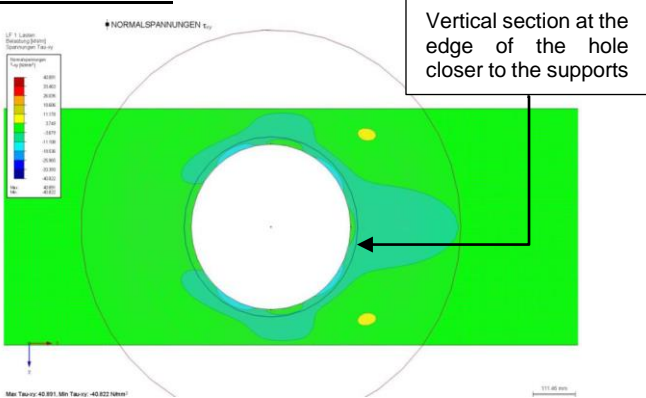

Figure 36: Shear stress distribution at the contour of a circular hole

For the computation of the maximum shear stresses, the shear factor k_τ of circular holes shall be determined as follows:

$$k_\tau = 0,62 \cdot \left[4,00 - \left(\frac{h_d}{h}\right)\right] \quad \text{Eq 144}$$

Remark:

(Compared to the currently given equation in ÖNORM B 1995-1-1:2015 [19] this equation given by Stora Enso leads to value for k_τ that are about 1/3 lower for circular holes of $\frac{h_d}{h} = 0,7$.)

8.5 Verification of longitudinal stresses- Bending

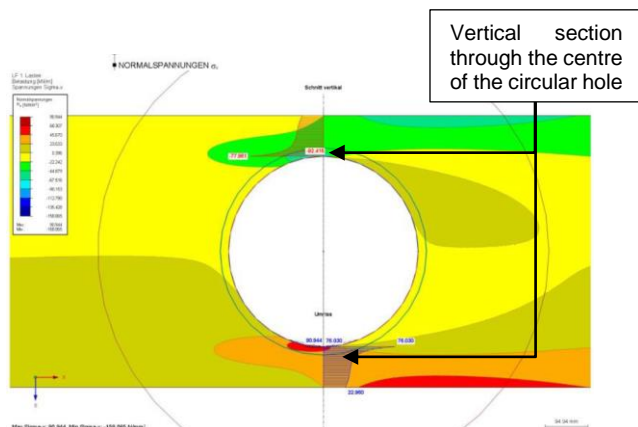

Figure 37: Longitudinal stresses at the contour of the hole and the edge of the beams

For circular holes:

while the longitudinal stresses for h_d/h ratios up to ≈ 0.30 are greater at the edge of the beam (see), for higher h_d/h values strongly increasing stresses at the circumference in the vertical section through the centre of the circular hole occur (see in Figure 37).

Thus if h_d/h ratios ≤ 0.7 shall be applied, in addition to the verification of the longitudinal stresses at the edge of the beam, given e. g. in the standard [19] , also the longitudinal stresses at the contour in the vertical section through the centre of the circular hole have to be verified (See Figure 37) .

The verification of the longitudinal stresses in the vertical profile can then be verified using the equation:

$$\sigma_{m,d} = \frac{M_d}{W} \cdot K_{M,0} \quad \text{Eq 145}$$

with $W = \frac{b \cdot h^2}{6}$



$$K_{M,0} = \left(\frac{h_d}{h}\right) \cdot \left[6,20 \cdot \left(\frac{h_d}{h}\right)^2 - 4,30 \cdot \left(\frac{h_d}{h}\right) + 4,45\right] \quad \text{Eq 146}$$

For rectangular holes: Similar to circular holes also at the contour, in particular at the corners of rectangular holes, pronounced stress peaks of the longitudinal stresses occur.

Verification at the edges of the hole:

The bending stress at the hole location presented in Figure 35 for rectangular and Figure 36 for circular depending on the $\frac{h_d}{h}$ ratio should satisfy the following expression:

$$\frac{\frac{M_d}{W_n} + \frac{M_{o,d}}{W_o}}{f_{m,d}} \leq 1 \quad \text{Eq 147}$$

and

$$\frac{\frac{M_d}{W_n} + \frac{M_{u,d}}{W_u}}{f_{m,d}} \leq 1 \quad \text{Eq 148}$$

where

$$M_{o,d} = \frac{A_o}{A_u + A_o} \cdot V_d \cdot \frac{a}{2} \quad \text{Eq 149}$$

$$M_{u,d} = \frac{A_u}{A_u + A_o} \cdot V_d \cdot \frac{a}{2} \quad \text{Eq 150}$$

$$A_o = b \cdot h_{ro} \quad \text{Eq 151}$$

$$A_u = b \cdot h_{ru} \quad \text{Eq 152}$$

$$W_o = \frac{b \cdot h_{ro}^2}{6} \quad \text{Eq 153}$$

$$W_u = \frac{b \cdot h_{ru}^2}{6} \quad \text{Eq 154}$$

with

- M_d Design value of the bending moment at the edge of the opening [N.mm];
- W_n Effective cross section modulus of the beam at the position of the opening [mm³];
- V_d Design value of the transversal force at the edge of the opening [N];
- $f_{m,d}$ Design value for the edgewise bending strength of the beam [N/mm²];
- $h_{ro}; h_{ru}$ Remaining heights of the net cross section [mm] According to the figures Figure 32 and Figure 33.

For circular holes it is sufficient to verify the bending stresses from the beam theory effect at the edges under consideration of the net cross section.

The bending stress at the location of a circular hole has to be verified by the equations:

$$\frac{\frac{M_d}{W_n}}{f_{m,d}} \leq 1 \quad \text{Eq 155}$$

The verification of the resistance against tension perpendicular to the grain stresses can be the most critical condition to fulfil in the design of holes in LVL G-S beams. LVL-X beams, on the other hand, offer a significant advantage for beams with holes, as the cross veneers act as reinforcement around the holes preventing cracking due to tension stresses perpendicular to the grain.

It is critically mentioned that in the known design standards no interaction of stresses, i.e. tensile stresses perpendicular to grain and shear stresses as well as longitudinal stresses within the verification process is required although they are simultaneously acting at the contour of the hole.



9. Connections with fasteners in LVL G's edge and wide face

The design of connections with metal fasteners is specified in Section 8 of Eurocode 5. However, the design instructions do not fully cover LVL products. This section therefore provides additional definitions for LVL based on expert document [9].

For the connection design of LVL members it is essential to note that the behaviour of the product may differ depending on whether the connections are on the wide face (flatwise) or on the edge face (edgewise) of the LVL, see Figure 38.

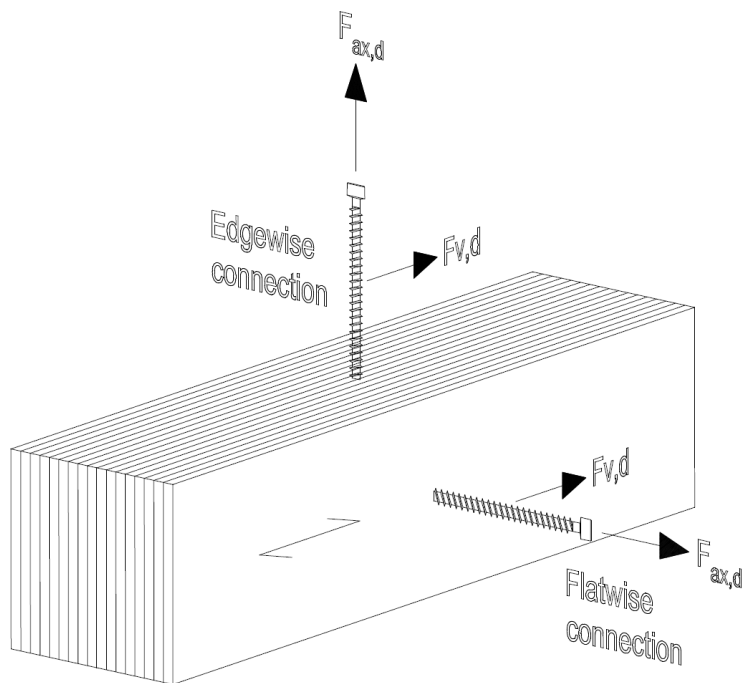

Figure 38: Edgewise (edge face) and flatwise (wide face) orientations and loading types of connections. $F_{ax,d}$ are forces of axially loaded and $F_{v,d}$ are forces of laterally loaded connections

Section 8.2 of Eurocode 5 provides equations for calculating the characteristic load-carrying capacity of nails, staples, bolts, dowels and screws for different failure modes according to the Johansen yield theory. The minimum value, based on the relevant failure modes for the connection type, should be taken as the capacity per shear plane per fastener.

The equations for determining the characteristic embedment $f_{h,k}$, withdrawal $f_{ax,k}$ and pull-through $f_{head,k}$ strengths in Stora Enso LVL G which are needed for the capacity calculation of laterally and axially loaded connections, are defined in the followings sections.

For other information like yield moment $M_{y,Rk}$, they are defined in sections 8.3-8.7 of EN1995-1-5. Alternatively, fastener suppliers provide their own design instructions for connections using their products in their ETA assessment documents.

The edge face of LVL is more sensitive to splitting, which must be taken into consideration when determining the geometry and maximum fastener sizes of connections.

LVL-X, on the other hand, has the advantage of ductile behaviour of connections on the wide face due to its cross veneers, thus eliminating a number of wood failure modes related to connections and enabling denser groups of fasteners.

A connection may be laterally loaded, axially loaded, or both laterally and axially loaded. For the determination of the characteristic lateral loadbearing capacity of connections with metal dowel-type fasteners, the contributions of the yield strength, embedment strength, and withdrawal strength of the fastener shall be considered.



9.1 Fastener angles, spacings, edge and end distances

9.1.1 Laterally loaded fasteners in wide and edge faces

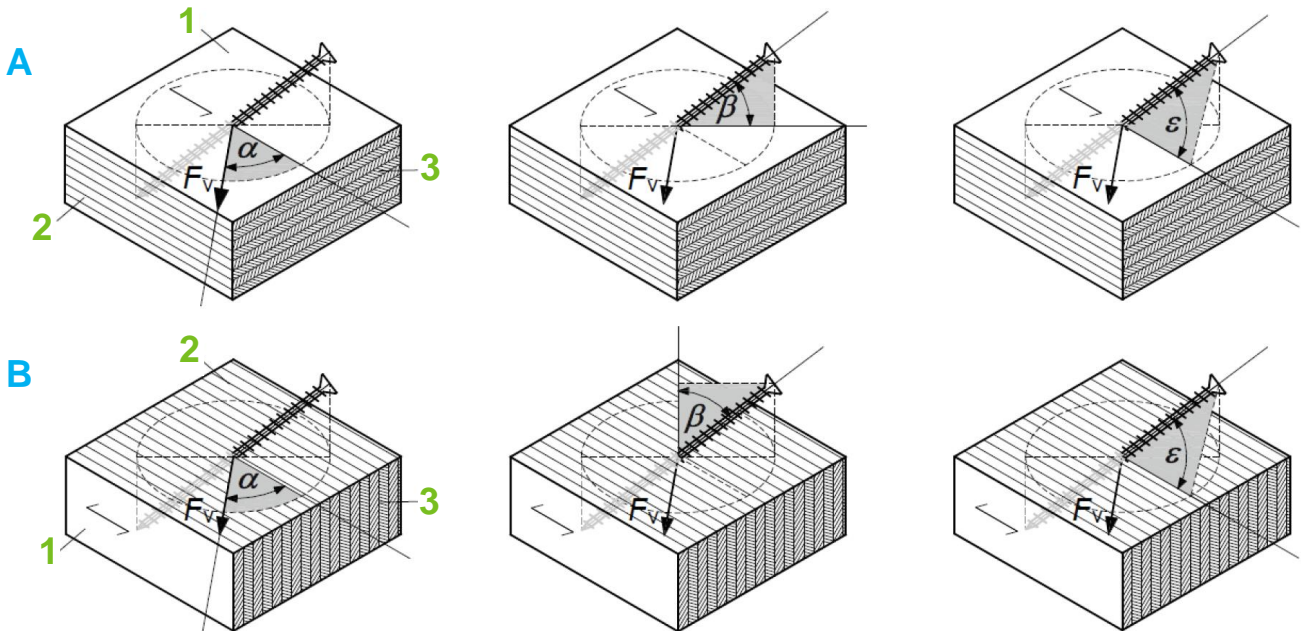

Figure 39: Definitions of angles α , β and ϵ for screws (A) in the wide face and (B) in the edge face of LVL. With 1) wide face, 2) edge face and 3) end grain.

α is the angle between the load and grain direction of laterally loaded connections.

β is the angle between the screw axis and wide face.

ϵ is the angle between screw axis and grain direction

9.1.2 Axially loaded fasteners

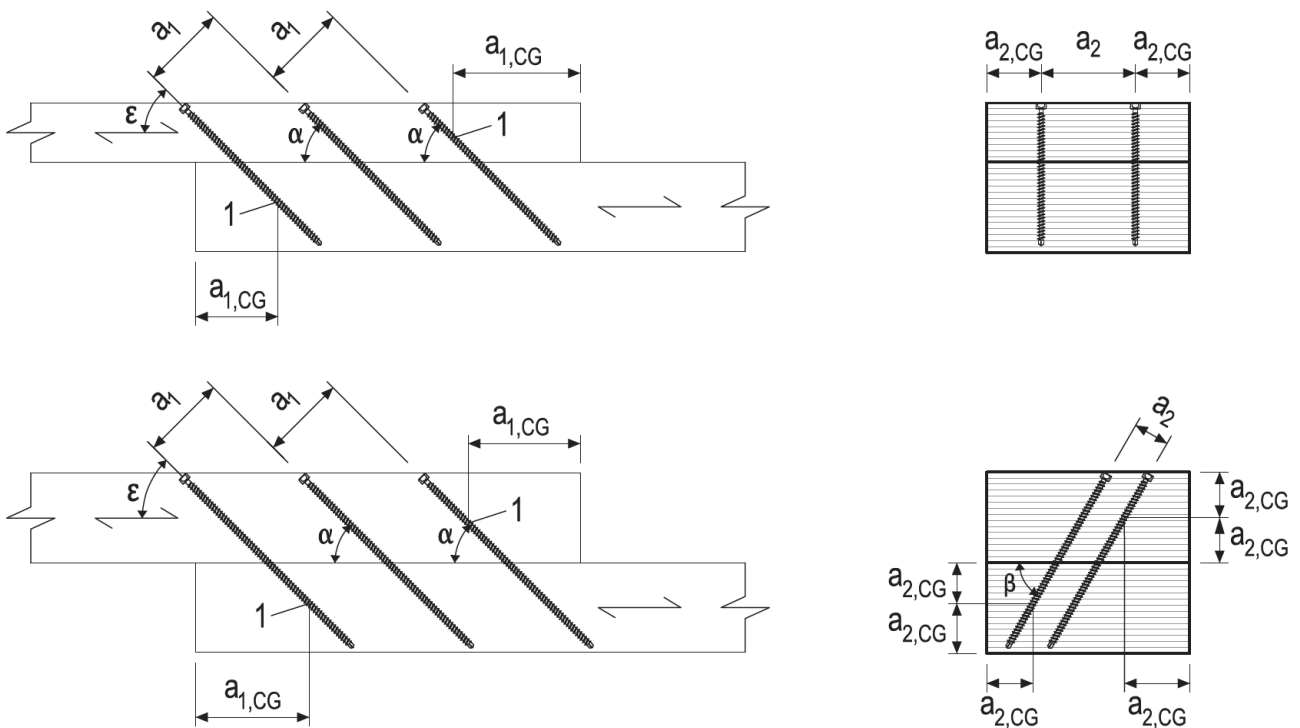

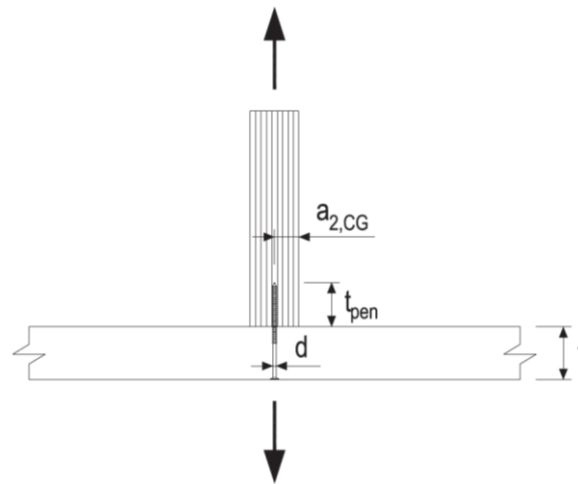

Figure 40: Spacings, end and edge distances and definitions of angles α , β and ϵ for axially loaded screws in LVL.

α is the angle between the shear plane and screw axis.

β is the angle between the screw axis and wide face.

ϵ is the angle between screw axis and grain direction. (modified from EC5 Figure 8.11a)

9.1.3 Minimum spacings, end distances and edge distances

The rules for fastener connection geometry without predrilling of LVL G-S on the wide face (flatwise connections) are similar to solid wood. In LVL G-X connections, the spacing between fasteners as well as end and edge distances can be smaller because the product is not sensitive to splitting, due to its cross veneers.

Connections at the edge face (edgewise), however, have a risk of splitting and require larger fastener spacing and end and edge distances for both LVL-S and LVL-X. Predrilling reduces the risk of splitting and smaller spacing and end and edge distances can be used.

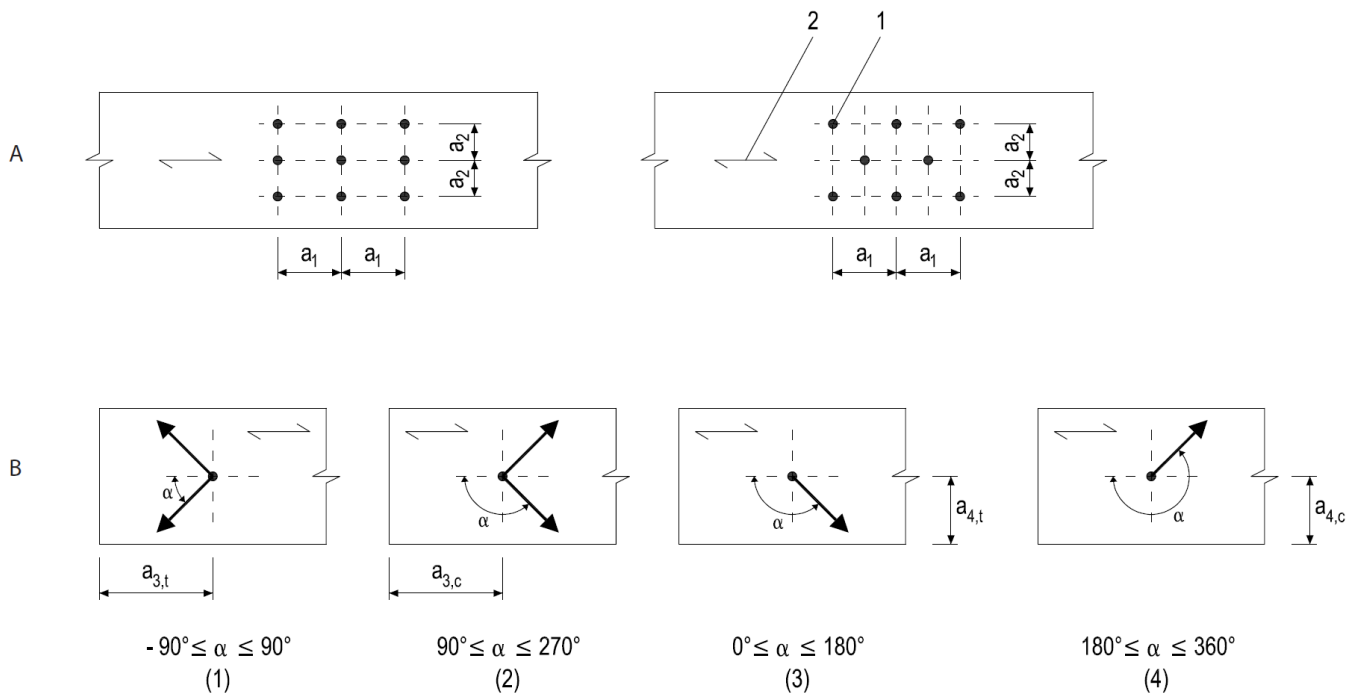

Figure 41: Spacings, end and edge distances (1 Fastener, 2 Grain direction (EC5 figure 8.7))

(A) Spacing parallel to grain in a row and perpendicular to grain between rows; (B) Edge and end distances; (1) Loaded end, (2) Unloaded end, (3) Loaded edge, (4) Unloaded edge;



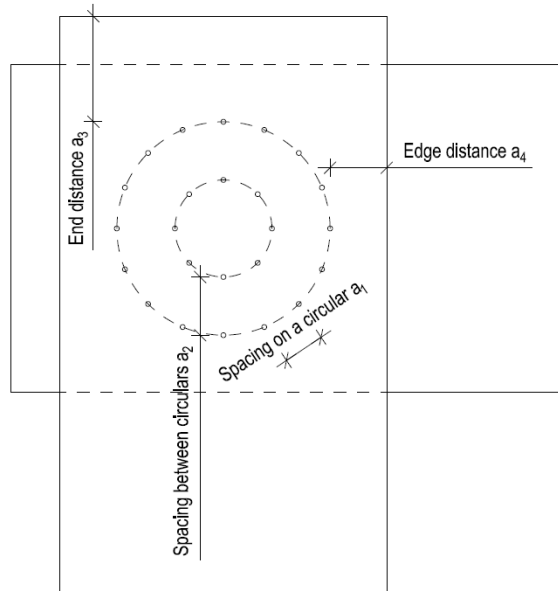

Figure 42: Moment-resisting multi-shear LVL-to-LVL flatwise connections with circular patterns of fasteners.

Table 11: Minimum spacings, end distances and edge distances for nails and screws with outer thread diameter <12 mm

(See Figure 41 and Figure 39)		Minimum spacing or end/edge distance			
		without predrilled holes			with predrilled holes
Laterally loaded connections Spacing or distance	Angle α	LVL or LVL G wide face	LVL or LVL G edge face	LVL-X or LVL G-X wide face when pointside penetration length of at least $10d^{a)}$	
Spacing a_1 (parallel to grain)	$0^\circ \leq \alpha \leq 360^\circ$	$d < 5 \text{ mm:}$ $(5 + 5 \cos \alpha) d$ $d \geq 5 \text{ mm:}$ $(5 + 7 \cos \alpha) d$	$(7 + 8 \cos \alpha) d$	$(5 + 2 \cos \alpha) d$	$(4 + \cos \alpha) d$
Spacing a_2 (perpendicular to grain)	$0^\circ \leq \alpha \leq 360^\circ$	$5d$	$7d$	$5d$	$(3 + \sin \alpha) d$
Distance $a_{3,l}$ (loaded end)	$-90^\circ \leq \alpha \leq 90^\circ$	$(10 + 5 \cos \alpha) d$	$(15 + 5 \cos \alpha) d$	$(4 + 3 \cos \alpha) d$	$(7 + 5 \cos \alpha) d^{b)}$
Distance $a_{3,c}$ (unloaded end)	$90^\circ \leq \alpha \leq 270^\circ$	$10d$	$15d$	$5d$	$7d^{c)}$
Distance $a_{4,l}$ (loaded edge)	$0^\circ \leq \alpha \leq 180^\circ$	$d < 5 \text{ mm:}$ $(5 + 2 \sin \alpha) d$ $d \geq 5 \text{ mm:}$ $(5 + 5 \sin \alpha) d$	$d < 5 \text{ mm:}$ $(7 + 2 \sin \alpha) d$ $d \geq 5 \text{ mm:}$ $(7 + 5 \sin \alpha) d$	$(3 + 4 \sin \alpha) d$	$d < 5 \text{ mm:}$ $(3 + 2 \sin \alpha) d$ $d \geq 5 \text{ mm:}$ $(3 + 4 \sin \alpha) d$
Distance $a_{4,c}$ (unloaded edge)	$180^\circ \leq \alpha \leq 360^\circ$	$5d$	$7d$	$3d$	$3d$

^{a)} When pointside penetration length is less than $10d$, the rules in the column LVL or LVL G wide face apply
^{b)} for LVL-C or LVL G-C wide face and pointside penetration length of at least $10d$: $(4 + 3 \cos \alpha) d$
^{c)} for LVL-C or LVL G-C wide face and pointside penetration length of at least $10d$: $5d$

(See Figure 40)		Minimum spacing or end/edge distance			
		without predrilled holes			with predrilled holes
Axially loaded screws Spacing or distance		LVL or LVL G wide face	LVL or LVL G edge face	LVL-X or LVL G-X wide face when pointside penetration length of at least $10d^{a)}$	
Spacing a_1 (parallel to grain)		$7d$	$10d$	$7d$	$7d$
Spacing a_2 (perpendicular to grain)		$5d$	$5d$	$5d$	$5d$
Minimum end distance of the centre of gravity of the threaded part of the screw in the member $a_{1,CG}$		$10d$	$12d$	$10d$	$10d$
Minimum edge distance of the centre of gravity of the threaded part of the screw in the member $a_{2,CG}$		$4d$	$4d$	$4d$	$4d$

Note: EN 1995-1-1:2004 (Eurocode 5) has a limit of $d_{ef} < 6 \text{ mm}$ which corresponds with 9 mm outer thread diameter. For shorter distance and spacing limits, ETA assessment document of screw manufacturers shall be consulted.



DESIGN MANUAL

Dec-20

Table 12: Minimum spacings, end distances and edge distances for bolts and screws with max outer thread diameter >12 mm with predrilled holes.

(See Figure 41 and Figure 39)		Minimum spacing or end/edge distance	
		LVL-S /LVL G-S or LVL-X/ LVL G-X edge face	LVL-X/ LVL G-X wide face
Laterally loaded connections	Angle α		
Spacing or distance			
Spacing a_1 (parallel to grain)	$0^\circ \leq \alpha \leq 360^\circ$	$(4 + 3 \cos \alpha) d$ ^{a)}	$4d$
Spacing a_2 (perpendicular to grain)	$0^\circ \leq \alpha \leq 360^\circ$	$4d$	$4d$
Distance $a_{3,t}$ (loaded end)	$-90^\circ \leq \alpha \leq 90^\circ$	$\max(7d; 105 \text{ mm})$ ^{b)}	$\max(4d; 60 \text{ mm})$ ^{c)}
Distance $a_{3,c}$ (unloaded end)	$90^\circ \leq \alpha < 150^\circ$	$(1 + 6 \sin \alpha) d$	$4d$
	$150^\circ \leq \alpha < 210^\circ$	$4d$	$4d$
	$210^\circ \leq \alpha \leq 270^\circ$	$(1 + 6 \sin \alpha) d$	$4d$
Distance $a_{4,t}$ (loaded edge)	$0^\circ \leq \alpha \leq 180^\circ$	$\max[(2 + 2 \sin \alpha) d; 3d]$	$\max[(2 + 2 \sin \alpha) d; 3d]$
Distance $a_{4,c}$ (unloaded edge)	$180^\circ \leq \alpha \leq 360^\circ$	$3d$	$3d$

^{a)} minimum spacing a_1 may be reduced to $5d$ if $f_{h,0,k}$ is multiplied by $\sqrt{a_1 / (4 + 3 |\cos \alpha|) d}$
^{b)} minimum end distance $a_{3,t}$ may be reduced to $7d$ for $d < 15 \text{ mm}$ if $f_{h,0,k}$ is multiplied by $a_{3,t} / 105 \text{ mm}$
^{c)} minimum end distance $a_{3,t}$ may be reduced to $4d$ for $d < 15 \text{ mm}$ if $f_{h,0,k}$ is multiplied by $a_{3,t} / 60 \text{ mm}$

Note: EN 1995-1-1:2004 has a limit of $d_{ef} < 6 \text{ mm}$ which corresponds with 9 mm outer thread diameter.

(See Figure 42)		Minimum spacing or end/edge distance		
		LVL-S /LVL G-S wide face	LVL-X/ LVL G-X wide face	Side member LVL-S / LVL G-S wide face
Spacing and end/edge distances on circular patterns for double shear moment-resisting connections				Middle member LVL-S, LVL G-S or LVL-X wide face
	Spacing a_1 (spacing on circle)	$6d$	$4d$	$5d$
Spacing a_2 (spacing between circles)	$5d$	$4d$	$5d$	$5d$
Distance $a_{3,t}$ (loaded end)	$6d$	$4d$	$6d$ in middle member $4d$ in side member	$6d$ in middle member $4d$ in side member
Distance $a_{4,t}$ (loaded edge)	$4d$	$3d$	$4d$ in middle member $3d$ in side member	$4d$ in middle member $3d$ in side member

Table 13: Minimum spacings, end distances and edge distances for 6-30 mm dowels

(See Figure 41 and Figure 39)		Minimum spacing or end/edge distance	
		LVL-S /LVL G-S or LVL-X/ LVL G-X edge face	LVL-X/ LVL G-X wide face
Laterally loaded connections	Angle α		
Spacing or distance			
Spacing a_1 (parallel to grain)	$0^\circ \leq \alpha \leq 360^\circ$	$(4 + 3 \cos \alpha) d$ ^{a)}	$(3 + \cos \alpha) d$
Spacing a_2 (perpendicular to grain)	$0^\circ \leq \alpha \leq 360^\circ$	$3d$	$3d$
Distance $a_{3,t}$ (loaded end)	$-90^\circ \leq \alpha \leq 90^\circ$	$\max(7d; 105 \text{ mm})$ ^{b)}	$\max(4d; 60 \text{ mm})$ ^{c)}
Distance $a_{3,c}$ (unloaded end)	$90^\circ \leq \alpha < 150^\circ$	$a_{3,t} \cos \alpha $	$(3 + \cos \alpha) d$
	$150^\circ \leq \alpha < 210^\circ$	$3d$	
	$210^\circ \leq \alpha \leq 270^\circ$	$a_{3,t} \cos \alpha $	
Distance $a_{4,t}$ (loaded edge)	$0^\circ \leq \alpha \leq 180^\circ$	$\max[(2 + 2 \sin \alpha) d; 3d]$	$\max[(2 + 2 \sin \alpha) d; 3d]$
Distance $a_{4,c}$ (unloaded edge)	$180^\circ \leq \alpha \leq 360^\circ$	$3d$	$3d$

^{a)} minimum spacing a_1 may be reduced to $5d$ if $f_{h,0,k}$ is multiplied by $\sqrt{a_1 / (4 + 3 |\cos \alpha|) d}$
^{b)} minimum end distance $a_{3,t}$ may be reduced to $7d$ for $d < 15 \text{ mm}$ if $f_{h,0,k}$ is multiplied by $a_{3,t} / 105 \text{ mm}$
^{c)} minimum end distance $a_{3,t}$ may be reduced to $4d$ for $d < 15 \text{ mm}$ if $f_{h,0,k}$ is multiplied by $a_{3,t} / 60 \text{ mm}$



storaenso

9.2 Nailed connections

9.2.1 Laterally loaded nails

For nails with diameters between 3 mm up to 8 mm arranged perpendicular to the grain, the following characteristic embedment strengths in Stora Enso LVL G apply:

Without predrilled holes:

$$f_{h,\beta,k} = \frac{0,082 \cdot \rho_k \cdot d^{-0,3}}{K_c \cdot \cos^2\beta + \sin^2\beta} \quad \text{Eq 156}$$

With predrilled holes:

$$f_{h,\beta,k} = \frac{0,082 \cdot (1 - 0,01 \cdot d) \cdot \rho_k}{K_c \cdot \cos^2\beta + \sin^2\beta} \quad \text{Eq 157}$$

Where

$f_{h,k}$ is the characteristic embedment strength [N/mm²];

ρ_k is the characteristic density [Kg/m³];

β is the angle between nail axis and face veneer plane;

d is the nail diameter [mm].

$K_c = 1$ for LVL G-S

$K_c = \min\left\{\frac{d}{3}, (d-2)\right\}$ for LVL G-X

To prevent splitting failure mode, for one row of n nails parallel to the grain, unless the nails of that row are staggered perpendicular to grain by at least $1d$, the load-carrying capacity parallel to the grain should be calculated using the effective number of fasteners $n_{ef} = n^{K_{ef}}$.

For nails in the edge face of LVL G, the parameter K_{ef} in EN 1995-1-1 equation (8.17) should be assumed as:

$$K_{ef} = \min\left\{1, \frac{1}{1 - 0.03\left(20 - \frac{a_1}{d}\right)}\right\} \quad \text{Eq 158}$$

for LVL-X:

$$K_{ef} = 1$$

for LVL-S:

K_{ef} in table 8.1 of EN1995-1-1 applies.

For smooth nails in pre-drilled holes in the edge face of LVL G the point side penetration length should be at least $12d$.

In the edge face of LVL G-X the minimum nail diameter d is 3mm.

Member thickness

LVL-S or LVL G-S with nails in the wide face should be pre-drilled when the thickness of the timber members is smaller than

$$t = \max\left\{\frac{7d}{(13d - 30) \cdot \frac{\rho_k}{400}}, 7d\right\} \quad \text{Eq 159}$$

t is the minimum thickness of timber member to avoid pre-drilling [mm]

Equation Eq 159 may be disregarded for nails in the wide face of LVL-X or LVL G-X



LVL or LVL G with nails in the edge face should be predrilled when the thickness of the member in nailing direction is smaller than

$$t = \max \left\{ \begin{array}{l} 14d \\ (13d - 30) \cdot \frac{\rho_k}{200} \end{array} \right. \quad \text{Eq 160}$$

Eq 159 may be replaced by Eq 160 for edge distances $a_4 \geq 14d$

9.2.2 Axially loaded nails

For smooth nails without predrilled holes and with a point side penetration of at least $12d$ in Stora Enso LVL G, the following characteristic values of the withdrawal and pull-through strengths apply:

$$f_{ax,k} = 20 \cdot 10^{-6} \cdot \rho_k^2 \quad \text{For wide face of LVL G} \quad \text{Eq 161}$$

$$f_{ax,k} = 0,32 \cdot d + 0,8 \quad \text{For edge face of LVL G} \quad \text{Eq 162}$$

The characteristic head pull-through parameter of axially loaded nails with head diameter $d_h \geq 1,8 \cdot d$ in Stora Enso LVL G is calculated according to EAD 130118-00-0603 section 2.2.5.1 Method 1:

$$f_{head,k} = 70 \cdot 10^{-6} \cdot \rho_k^2$$

$$f_{head,k} = 12N/mm^2$$

However, smooth nails shall not be used to resist permanent or longterm axial loading.

The following information should be taken from the nail supplier's DoP:

- Characteristic yield moment $M_{y,k}$ [N.mm]
- Characteristic withdrawal parameter $f_{ax,k}$ [N/mm²]
- Characteristic head out-through parameter $f_{head,k}$ [N/mm²]
- Characteristic tensile capacity $f_{tens,k}$ [kN]
- Nail diameter [mm]
- Nail head area [mm²]
- Nail length [mm]
- For threaded nails also length of threaded part (l_g) and length of point (l_p)

9.3 Bolted and doweled connections

9.3.1 Laterally loaded bolts or dowels

For bolts or dowels up to 30 mm diameter arranged perpendicular to the grain, the following characteristic embedment strength values in Stora Enso LVL G should be used:

$$f_{h,\alpha,\beta,k} = \frac{0,082 \cdot (1 - 0,01 \cdot d) \cdot \rho_k}{(K_{90} \cdot \sin^2 \alpha + \cos^2 \alpha) \cdot (K_c \cdot \cos^2 \beta + \sin^2 \beta)} \quad \text{Eq 163}$$

Where

$f_{h,0,k}$ is the characteristic embedment strength parallel to grain [N/mm²];

ρ_k is the characteristic density [Kg/m³];

β is the angle between bolt axis and face veneer;

α is the angle between load and grain direction; for X-grade and $\alpha > 45^\circ$, α may be set as 45° ;

d is the bolt diameter [mm].

$$K_{90} = 1,15 + 0,015d \quad \text{Eq 164}$$

$$K_c = \max \left\{ \begin{array}{l} d/(d - 2) \\ 1,15 \end{array} \right. \quad \text{Eq 165}$$

The minimum spacing a_1 should be $(4 + 3 |\cos \alpha|) \cdot d$ and the minimum distance to the loaded end, $a_{3,t}$ should not be lower than 105 mm.



9.4 Screwed connections

Screw suppliers also have their own design instructions for their fasteners documented in their ETAs and DoPs. These must be treated as separate supplier-specific instructions unless they make direct reference to Eurocode design. The following information should be taken from the screw supplier's DoP:

- Characteristic yield moment $M_{y,k}$ [Nmm]
- Characteristic withdrawal parameter $f_{ax,k}$ [N/mm²]
- Characteristic head out-through parameter $f_{head,k}$ [N/mm²]
- Characteristic tensile capacity $f_{tens,k}$ [kN]
- Screw outer thread diameter d [mm]
- Screw inner thread diameter d_1 [mm]
- Screw head diameter d_h [mm]
- Screw length L [mm]
- Thread length L_G [mm]

9.4.1 Laterally loaded screws

The effect of the threaded part of the screw shall be taken into account in determining the load carrying capacity by using the yield moment capacity of the screw determined in accordance with EN 14592. The outer thread diameter d shall be used to determine the embedment strength, the spacing, edge and end distances and the effective number of screws.

The embedding strength for screws in Stora Enso LVL G should be taken as follows.

Screws with an outer thread diameter $d \leq 12$ mm in non-predrilled LVL G members:

$$f_{h,\beta,\varepsilon,k} = \frac{0,082 \cdot \rho_k \cdot d^{-0,3}}{(K_c \cdot \cos^2 \beta + \sin^2 \beta) \cdot (2,5 \cdot \cos^2 \varepsilon + \sin^2 \varepsilon)} \quad \text{Eq 166}$$

Screws with an outer thread diameter $d \leq 12$ mm in predrilled LVL G members:

$$f_{h,\beta,\varepsilon,k} = \frac{0,082 \cdot (1 - 0,01 \cdot d) \cdot \rho_k}{(K_c \cdot \cos^2 \beta + \sin^2 \beta) \cdot (2,5 \cdot \cos^2 \varepsilon + \sin^2 \varepsilon)} \quad \text{Eq 167}$$

Screws with an outer thread diameter $d > 12$ mm in predrilled LVL G members:

$$f_{h,\alpha,\beta,\varepsilon,k} = \frac{0,082 \cdot (1 - 0,01 \cdot d) \cdot \rho_k}{(K_{90} \cdot \sin^2 \alpha + \cos^2 \alpha) \cdot (K_c \cdot \cos^2 \beta + \sin^2 \beta) \cdot (2,5 \cdot \cos^2 \varepsilon + \sin^2 \varepsilon)} \quad \text{Eq 168}$$

Where

$$K_{90} = 1,15 + 0,015d \quad \text{Eq 169}$$

$$K_c = 1 \quad \text{for LVL G-S and } d \leq 12 \text{ mm} \quad \text{Eq 170}$$

$$K_c = \min \left\{ \frac{d}{3}, \frac{d}{d-2} \right\} \quad \text{for LVL G-X and } d \leq 12 \text{ mm} \quad \text{Eq 171}$$

$$K_c = \min \left\{ \frac{d}{1,15}, \frac{d}{d-2} \right\} \quad \text{for } d > 12 \text{ mm} \quad \text{Eq 172}$$

d is the outer thread diameter [mm];

$f_{h,0,k}$ is the characteristic embedment strength parallel to grain [N/mm²];

ρ_k is the characteristic density [Kg/m³];

α is the angle between load and grain direction;

β is the angle between screw axis and wide face;

ε is the angle between screw axis and grain direction.

Different types or sizes of screws must not be combined in the same connection. All screws must be positioned at the same inclination angles ε and β in a member. The screws must be positioned centrally to the connection force and screwed deep enough so that the screw head is in full contact with the member surface. The minimum pointside penetration depth of the threaded part should be 6d. The members should be compressed together so that no gaps are present.



DESIGN MANUAL

Dec-20

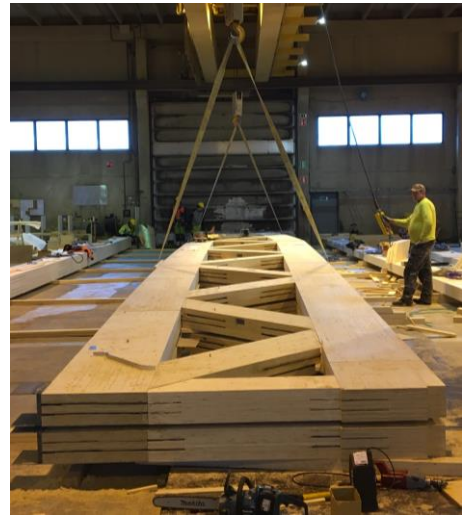

Figure 43: Left: Bolted connection for LVL G columns in production (Wood city project, Finland); Right: Screwed connection for LVL G trusses in production (Ydalir project, Norway)



Figure 44: Left: Bolted connection for LVL G columns on construction site (Wood city project, Finland); Right: Screwed connection for LVL G trusses in delivery (Ydalir project, Norway)

9.4.2 Axially loaded screws

For connections in LVL / LVL G with $\varepsilon \geq 15^\circ$ of screws in accordance with EN 14592 with:

- $6 \text{ mm} \leq d \leq 12 \text{ mm}$ and $0,6 \leq d_1/d \leq 0,75$
 d is the outer thread diameter; and d_1 is the inner thread diameter

The following failure modes should be verified when assessing the load-carrying capacity of connections with axially loaded screws:

- the withdrawal capacity of the threaded part of the screw;
- for screws used in combination with steel plates, the tear-off capacity of the screw head should be greater than the tensile strength of the screw;
- the pull-through strength of the screw head;
- the tension strength of the screw;
- for screws used in conjunction with steel plates, failure along the circumference of a group of screws (block shear or plug shear);

Note: Failure modes in the steel or in the timber around the screw are brittle, i.e. with minimal ultimate deformation and therefore have a limited possibility for stress redistribution.

Minimum spacing and edge distances for axially loaded screws should be taken from Table 11 and Table 12.

For screws in the edge face of Stora Enso LVL G, the following characteristic withdrawal and pull-through capacities apply:

$$f_{ax,\varepsilon,Rk} = \frac{k_{ax} \cdot f_{ax,90,k}}{(1,5 \cdot \cos^2 \beta + \sin^2 \beta)} \cdot \left(\frac{\rho_k}{\rho_a}\right)^{0,8} \quad \text{Eq 173}$$

$$F_{ax,\varepsilon,Rk} = \frac{n_{ef} \cdot k_{ax} \cdot f_{ax,90,k} \cdot d \cdot l_{ef}}{(1,5 \cdot \cos^2 \beta + \sin^2 \beta)} \cdot \left(\frac{\rho_k}{\rho_a}\right)^{0,8} \quad \text{Eq 174}$$

$$F_{ax,\varepsilon,Rk} = \frac{n_{ef} \cdot k_{ax} \cdot 14,5 \cdot d \cdot l_{ef}}{(1,5 \cdot \cos^2 \beta + \sin^2 \beta)} \quad \text{Eq 175}$$

$$K_{ax} = 0,5 + \frac{0,5 \cdot \varepsilon}{45^\circ} \quad \text{For } 15^\circ \leq \varepsilon < 45^\circ \quad \text{Eq 176}$$

$$K_{ax} = 1 \quad \text{For } 45^\circ \leq \varepsilon < 90^\circ \quad \text{Eq 177}$$

where

$$l_{ef} = \min \left\{ \begin{array}{l} \frac{6 \cdot d}{\sin \varepsilon}; \\ 20 \cdot d \end{array} \right.$$

- $F_{ax,\varepsilon,Rk}$ is the characteristic withdrawal capacity of the connection at an angle ε to the grain [N];
- $f_{ax,90,k}$ is the characteristic withdrawal strength perpendicular to the grain determined in accordance with EN 14592 for the associated density ρ_a [N/mm²];
- n_{ef} is the effective number of screws, $n_{ef} = n^{0,9}$ where n is the number of screws acting together in a connection;
- d is the outer thread diameter [mm];
- l_{ef} is the penetration length of the threaded part [mm];
- ρ_k is the characteristic density [Kg/m³];
- ρ_a is the associated density for $f_{ax,k}$ [kg/m³];
- β is the angle between screw axis and the LVL's wide face veneer, $0^\circ \leq \beta < 90^\circ$;
- K_{ax} is a factor to consider the influence of the angle ε between screw axis and grain direction and the long-term behavior;



ε is the angle between the screw axis and the grain direction, with $\varepsilon \geq 15^\circ$.

For screws in LVL G, the characteristic withdrawal parameter may be assumed as $f_{ax,90,k} = 15 \text{ N/mm}^2$, when $\rho_a = 500 \text{ kg/m}^3$ and screws $6 \text{ mm} \leq d \leq 12 \text{ mm}$ in Stora Enso LVL G.

The characteristic pull-through resistance of connections with axially loaded screws should be taken as:

$$F_{ax,\varepsilon,Rk} = n_{ef} \cdot f_{head,k} \cdot d_h^2 \cdot \left(\frac{\rho_k}{\rho_a}\right)^{0,8} \quad \text{Eq 178}$$

where

- $F_{ax,\varepsilon,Rk}$ is the characteristic pull-through capacity of the connection at an angle ε to the grain with $\varepsilon \geq 30^\circ$ [N];
- $f_{head,k}$ is the characteristic pull-through parameter of the screw determined in accordance with EN 14592 for the associated density ρ_a [N/mm²];
- d_h is the diameter of the screw head [mm]

9.4.3 Tension screwed connection

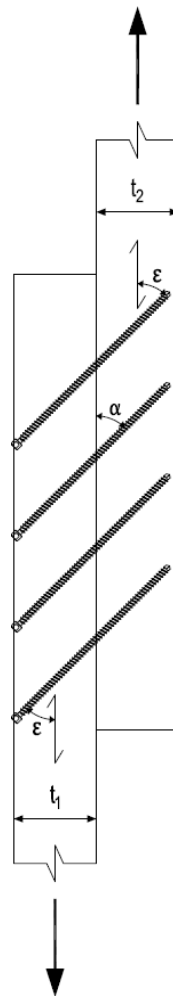

Figure 45: Tension screw connection

DESIGN MANUAL

Dec-20

In a joint consisting of only screws in tension, contact between the wood members is required. Tension screw connection should not be used in conditions where wood drying could cause a gap of over $0,2 \cdot d$. The gap is determined from the shrinkage (See chapter 3.4) at a thickness of the LVL G members in the screw length ($L \cdot \sin \alpha$).

The characteristic withdrawal capacity of the screw is calculated by the following equation:

$$R_{T,k} = \min \begin{cases} f_{ax,\varepsilon,1,k} \cdot d \cdot l_{g,1} + f_{head,k} \cdot d_h^2 \cdot \left(\frac{\rho_k}{\rho_a}\right)^{0,8} \\ f_{ax,\varepsilon,2,k} \cdot d \cdot l_{g,2} \\ f_{tens,k} \end{cases} \quad \text{Eq 179}$$

When the screwing direction in the beam is $\varepsilon = 90^\circ$ to the grain direction (eventhough the angle β is inclined between the edge face and the wide face), it is not allowed to add the tension capacity of the head to the withdrawal capacity of the threaded part in the beam. Therefore the characteristic withdrawal capacity $R_{T,k}$ of the screw is calculated by the following equation:

$$R_{T,k} = \min \begin{cases} \max \left(f_{ax,90,1,k} \cdot d \cdot l_{g,1}; f_{head,k} \cdot d_h^2 \cdot \left(\frac{\rho_k}{\rho_a}\right)^{0,8} \right) \\ f_{ax,\varepsilon,2,k} \cdot d \cdot l_{g,2} \\ f_{tens,k} \end{cases} \quad \text{Eq 180}$$

The characteristic load-carrying capacity of the tension screw connection, (see) is calculated by the equation:

$$R_k = n^{0,9} \cdot R_{T,k} \cdot (\cos \varepsilon + \mu \cdot \sin \varepsilon) \quad \text{Eq 181}$$

where

- $f_{ax,\varepsilon,k}$ is the characteristic withdrawal strength for a screw at the head side or pointside member of the connection at an angle ε to the grain direction according to Eq 173 [N/mm²];
- n is the number of screws in the connection;
- $l_{g,1}$ is the penetration length of the threaded part in the head side member [mm];
- $l_{g,2}$ is the penetration length of the threaded part in the pointside member [mm];
- $R_{T,k}$ is the characteristic withdrawal capacity, see or [N];
- α is the angle between screw axis and the shear plane ($30^\circ \leq \alpha \leq 60^\circ$);
- $f_{tens,k}$ is the characteristic tensile capacity of the screw determined in accordance with EN 14592 [N];
- μ is the kinetic friction coefficient between the members, the following values may be used:
 - 0,26 for untreated LVL edgewise or LVL to timber connections
 - 0,30 for steel-to-timber connections
 - 0,40 for untreated LVL flatwise connections



10. Serviceability Limit States

10.1 Deflection

The deformation of a structure resulting from the effects of actions (such as axial and shear forces, bending moments and joint slip) and from moisture shall remain within appropriate limits, having regard to the possibility of damage to surfacing materials, ceilings, floors, partitions and finishes, and to the functional needs as well as any appearance requirements. Limiting values for deformation are taken from EN1995-1-1 and the applicable national annex.

Deformation need to be also limited so that action of the adjacent structures and the intended operation of the building is not disturbed.

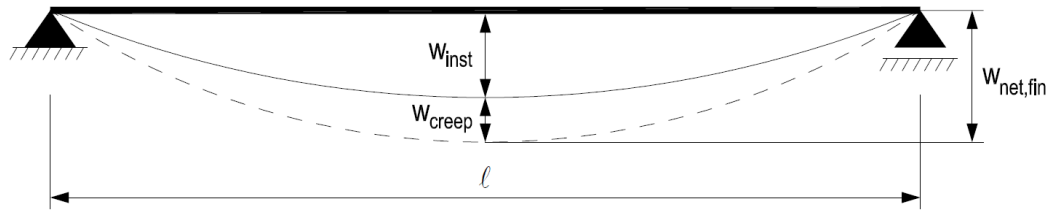

Figure 46: Components of deflection of LVL members.

Normally limiting deflections for the beams are according to the limits below:

For the instantaneous deflection limit is used

$$w_{inst} \leq \frac{L}{300} \text{ to } \frac{L}{500} \quad \text{Eq 182}$$

and the final net deflection limit

$$w_{net,fin} \leq \frac{L}{250} \text{ to } \frac{L}{350} \quad \text{Eq 183}$$

The final net deflection limit for slab between the ribs

$$w_{net,fin} \leq \frac{L}{200} \quad \text{Eq 184}$$

These limits shall be used in design according the suitable National Annex.

The instantaneous deflection may be calculated as:

$$w_{inst} = \underbrace{\sum_{j \geq 1} w_{inst,G,j} + w_{inst,Q1} + \sum_{i > 1} \psi_{0,i} \cdot w_{inst,Q,i}}_{\text{characteristic load combination}} \quad \text{Eq 185}$$

The final deflection may be calculated as:

$$w_{fin} = w_{fin,G} + w_{fin,Q,1} + \sum w_{fin,Q,i}$$

$$w_{fin} = \underbrace{w_{inst}}_{\text{characteristic load combination}} + \underbrace{w_{creep}}_{\text{quasi permanent load combination}}$$

$$= \underbrace{\sum_{j \geq 1} w_{inst,G,j} + w_{inst,Q1} + \sum_{i > 1} \psi_{0,i} \cdot w_{inst,Q,i}}_{\text{characteristic load combination}} + \left[\underbrace{\sum_{j \geq 1} w_{inst,G,j} + \sum_{i \geq 1} \psi_{2,i} \cdot w_{inst,Q,i}}_{\text{quasi permanent load combination}} \right] \cdot k_{def,i} \quad \text{Eq 186}$$



The creep deformation should be calculated using mean values of the appropriate moduli of elasticity, shear moduli and slip moduli and the relevant values of k_{def} given in Table 5: Values of the deformation factor k_{def} .

with:

Final deflection caused by permanent action

$$w_{fin,G} = w_{inst,G}(1 + k_{def}) \quad \text{Eq 187}$$

Final deflection caused by the leading variable action

$$w_{fin,Q,1} = w_{inst,Q,1}(1 + \psi_{2,1} \cdot k_{def}) \quad \text{Eq 188}$$

Final deflection caused by the accompanying variable action

$$w_{fin,Q,i} = w_{inst,Q,i}(\psi_{0,i} + \psi_{2,i} \cdot k_{def}) \quad \text{Eq 189}$$

The net final deflection may be calculated as:

$$w_{net,fin} = \underbrace{\sum_{j \geq 1} w_{inst,G,j} + w_{inst,Q,1} + \sum_{i > 1} \psi_{0,i} \cdot w_{inst,Q,i}}_{\substack{\text{characteristic load combination} \\ - w_c \\ \text{camber}}} + \underbrace{\left[\sum_{j \geq 1} w_{inst,G,j} + \sum_{i \geq 1} \psi_{2,i} \cdot w_{inst,Q,i} \right]}_{\text{quasi permanent load combination}} \cdot k_{def,i} \quad \text{Eq 190}$$

$w_{inst,G}$ is instantaneous deformation for action G

$w_{inst,Q,1}$ is instantaneous deformation for action Q_1

$w_{inst,Q,i}$ is instantaneous deformation for action Q_i

When calculating instantaneous deformation, shear deformation shall be considered and mean values of stiffness properties shall be used in the analysis.

As an example, the deflection of a single-span beam under a "1.0kN/mm" uniformly distributed load is calculated from equation:

$$w_1 = \frac{5 \cdot "1" \cdot l^4}{384 \cdot (E_0 \cdot I)} + \frac{"1" \cdot l^2}{8 \cdot (GA)_{ef}} \quad \text{Eq 191}$$

and for a "1.0 kN" point load in the middle of the span:

$$w_1 = \frac{"1" \cdot l^3}{48 \cdot (E_0 \cdot I)} + \frac{"1" \cdot l^2}{4 \cdot (GA)_{ef}} \quad \text{Eq 192}$$

With

$$(GA)_{ef} = G_{mean} \cdot A \cdot \kappa = \frac{G_{mean} \cdot A \cdot 5}{6}$$

$\kappa = \frac{5}{6}$ is the shear deformation factor for rectangular cross section

- Instantaneous deflection w_{inst} due to the characteristic load combination

$$w_{inst} = w_{1,inst} \cdot \left(g_k + q_{1,k} + \sum_{i > 1} \psi_{0,i} \cdot q_{i,k} \right) \cdot s \quad \text{Eq 193}$$

- Net final deflection $w_{net,fin}$ due to the characteristic and quasi-permanent load combinations

$$w_{net,fin} = \left\{ w_{1,inst} \cdot \underbrace{\left[g_k + q_{1,k} + \sum_{i > 1} \psi_{0,i} \cdot q_{i,k} \right]}_{\text{characteristic loading}} + w_{1,inst} \cdot \underbrace{\left[g_k + \sum_{i \geq 1} \psi_{2,i} \cdot q_{i,k} \right]}_{\text{quasi permanent loading}} \cdot k_{de} \right\} \cdot s \quad \text{Eq 194}$$

s being the tributary of the beam



10.2 Vibration

The vibration control is made by setting limits to the natural frequency and on the flexibility. The vibration analysis shall be executed according to EN1995-1-1 and the applicable national annex.

In case an applicable national annex to a Eurocode standard is deviating from given recommendations in this document, automatically the national annex is governing.

In the basic edition of EN 1995-1-1, the vibration design is very poorly regulated. Currently the **Austrian national annex** of EN1995-1-1 contains the most extensive vibration design guide lines.

The following criterions on vibration design are available – most of them being mandatory to meet – others only optional:

- Class criterion:

Floor class I	Floor class II
One floor element spanning across different occupancy units (apartments with different owners) on the same level	One floor element spanning within the same occupancy unit (apartments with same owner) on the same level
Wet floating screed installed on top of light or heavy granular fill.	Wet screed installed with or without granular fill below
Dry screed installed on top of heavy granular fill (> 60 kg/m ²)	

- Frequency Criterion:

Floor class I	Floor class II
One floor element spanning across different occupancy units (apartments with different owners) on the same level	One floor element spanning within the same occupancy unit (apartments with same owner) on the same level
$f_1 \geq 8 \text{ Hz}$	$f_1 \geq 6 \text{ Hz}$

Fundamental frequency f_1 of the section may be calculated as:

$$f_1 = \frac{\pi}{2 \cdot l^2} \sqrt{\frac{(EI)_{l,eff}}{m} \cdot \sqrt{1 + \left(\frac{l}{b_R}\right)^4 \cdot \frac{(EI)_{b,eff,1m}}{(EI)_{l,eff,1m}}}} \quad \text{Eq 195}$$

accounting for rigidity in cross direction

f_1	First fundamental frequency [Hz]
$(EI)_{l,eff,1m}$	Flexural rigidity in longitudinal direction for 1m wide (if spacing is not exactly 1m → extrapolation to a 1m wide element) in Nm ² /m. The flexural rigidity is based on the mean value of the Young's modulus and the effective moment of inertia. If a floating screed is present in the floor layup, the rigidity of the screed $E_{l,screed}$ can be added too.
$(EI)_{b,eff,1m}$	Analogous to $(EI)_{l,eff,1m}$, only in cross direction (perpendicular to the span direction [Nm ² /m]). This is the flexural rigidity in cross direction of the horizontal structural floor + the screed rigidity, if any.
m	Mass of the structure in kg/m ² = $\sum_{i \geq 1} G_{k,i}$ [kg/m ²]
b_R	Width of the entire floor (not necessarily limited to the panel width – usually width of a room)
l	Span [m]



- Acceleration criterion (optional, if frequency criterion is not met):

Floor class I	Floor class II
One floor element spanning across different occupancy units (apartments with different owners) on the same level	One floor element spanning within the same occupancy unit (apartments with same owner) on the same level
$f_1 \geq 4,5 \text{ Hz}$	$f_1 \geq 4,5 \text{ Hz}$
$a_{rms} \leq 0,05 \text{ m/s}^2$	$a_{rms} \leq 0,10 \text{ m/s}^2$
Eq 196	
$a_{rms} = \frac{0,4 \cdot e^{-0,40 \cdot f_1} \cdot F_0}{2 \cdot \zeta \cdot \underbrace{\left[\frac{m \cdot l \cdot b_R}{2} \right]}_{\text{modal mass } M^*}}$	
f_1	First fundamental frequency [Hz]
F_0	Weight of 700N (defined in [8], Austrian NA, ...related to the average weight of a human)
ζ	Damping ratio. a damping ratio of 4% shall be assumed (0,04)
m	Mass of the structure in $\text{kg/m}^2 = \sum_{i \geq 1} G_{k,i}$ [kg/m^2]
b_R	Width of the entire floor (not necessarily limited to the panel width – usually width of a room)
l	Span [m]

- Stiffness criterion:

Floor class I	Floor class II
One floor element spanning across different occupancy units (apartments with different owners) on the same level	One floor element spanning within the same occupancy unit (apartments with same owner) on the same level
$w_{1kN} \leq 0,25 \text{ mm}$	$w_{1kN} \leq 0,50 \text{ mm}$
Eq 197	
$w_{1kN} = \frac{F \cdot l^3}{48 \cdot (EI)_{l,eff,1m} \cdot \left[\frac{l}{1,1} \cdot \sqrt[4]{\frac{(EI)_{b,eff,1m}}{(EI)_{l,eff,1m}}} \right]} + \frac{F \cdot l}{4 \cdot (GA)_{l,eff,1m} \cdot \left[\frac{l}{1,1} \cdot \sqrt[4]{\frac{(EI)_{b,eff,1m}}{(EI)_{l,eff,1m}}} \right]}$	
f_1	First fundamental frequency [Hz]
$(EI)_{l,eff,1m}$	Flexural rigidity in longitudinal direction for 1m wide (if spacing is not exactly 1m → extrapolation to a 1m wide element) in Nm^2/m . The flexural rigidity is based on the mean value of the Young's modulus and the effective moment of inertia. If a floating screed is present in the floor layup, the rigidity of the screed Elscreeed can be added too.
$(EI)_{b,eff,1m}$	Analogous to $(EI)_{l,eff,1m}$, only in cross direction (perpendicular to the span direction [Nm^2/m]). This is the flexural rigidity in cross direction of the horizontal structural floor + the screed rigidity, if any.
F for 1 section	Point load of 1 kN
$(GA)_{l,eff,1m}$	Shear stiffness of the rib panel in longitudinal direction for a 1m wide rib panel (if rib spacing is not exactly 1m → extrapolation to a 1m wide element)
l	Span [m]



The vibration design according to Austrian NA shall be summarized in the following flow chart:

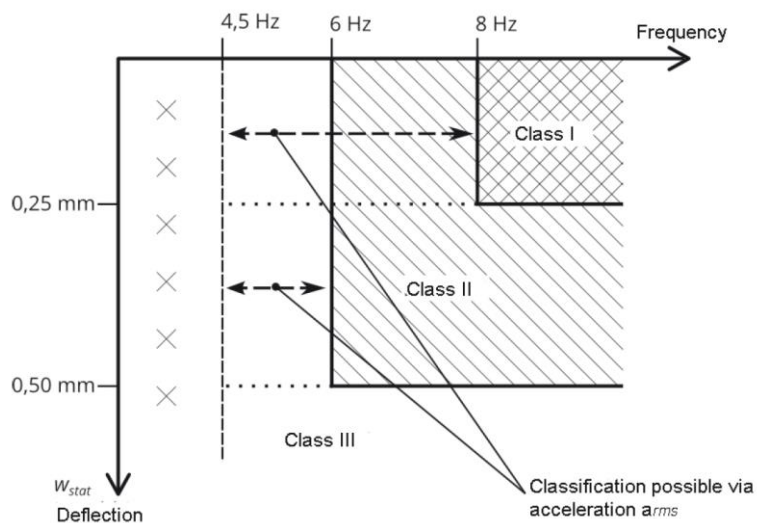
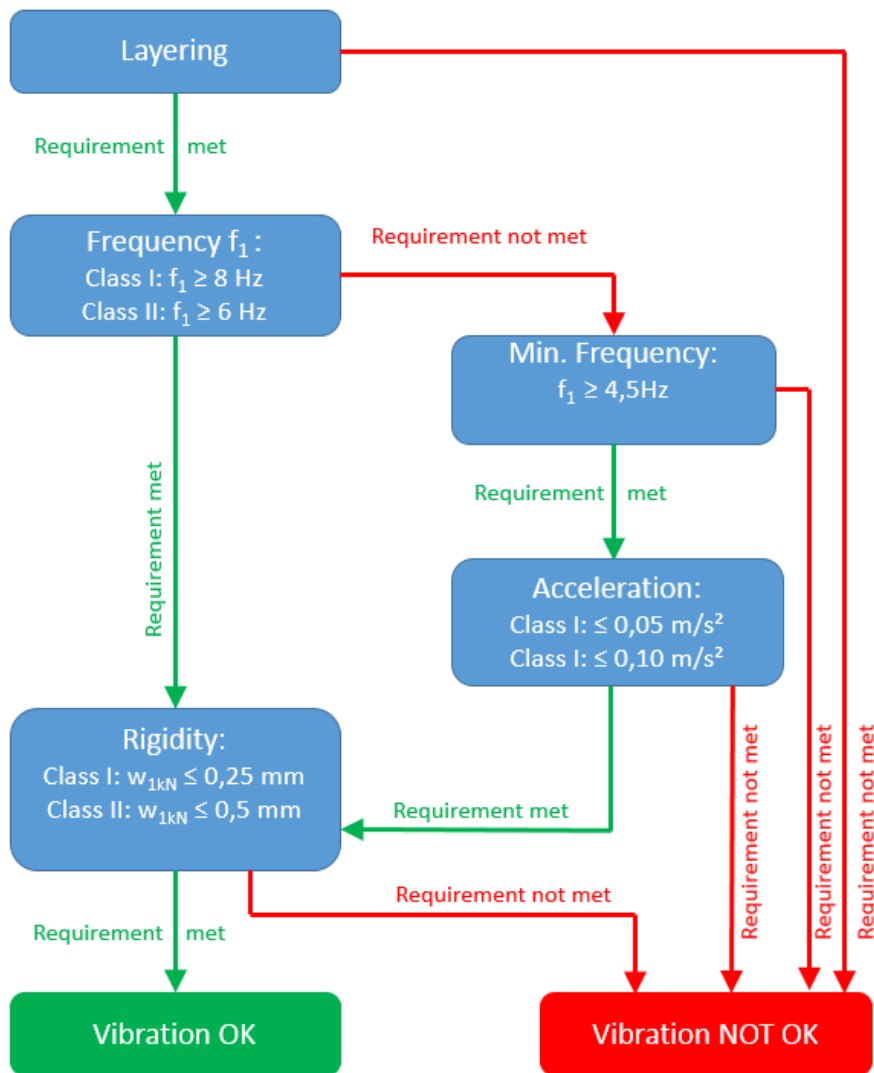

11. Safety in case of fire

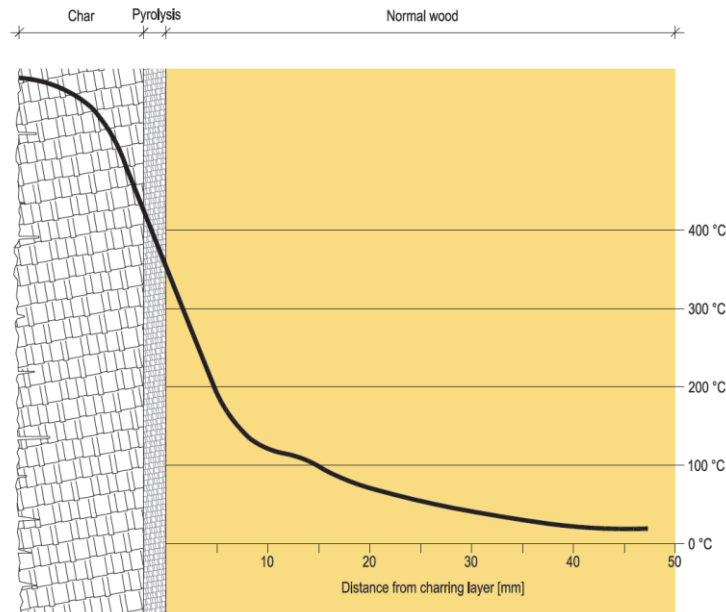

Figure 47: Temperature gradient in burning wood. The temperature drops significantly behind the charring layer. 15 mm from the charring- LVL Handbook EUROPE [10]

LVL is a combustible material. It starts to burn at the surface at a temperature of 270°C when exposed to flame. However, self-ignition does not occur at temperatures below 400 °C. According to structural fire design part of Eurocode 5 (EN1995-1-2) [22], the start of charring is defined as the point at which the temperature of timber surface reaches 300 °C. At 200–300 °C, the long-chain molecules in the cell walls split, producing gaseous and flammable compounds and the gas subsequently enters the surface of the wood where it reacts with oxygen in the air, and combusts. These chemical compounds decompose in a process known as “pyrolysis” (whereby gas emissions from combustible components in the wood burst into flame), gradually spreading along the wood, leaving a charring area behind it. Burning creates a char layer on the surface of wood products. The char layer acts as an insulation layer, which slows the burning and protects the rest of the cross section, see Figure 47. However, the high temperature prior to burning reduces the strength and stiffness properties of the wood even before charring, see Figure 48, which must be taken into account in structural fire design.

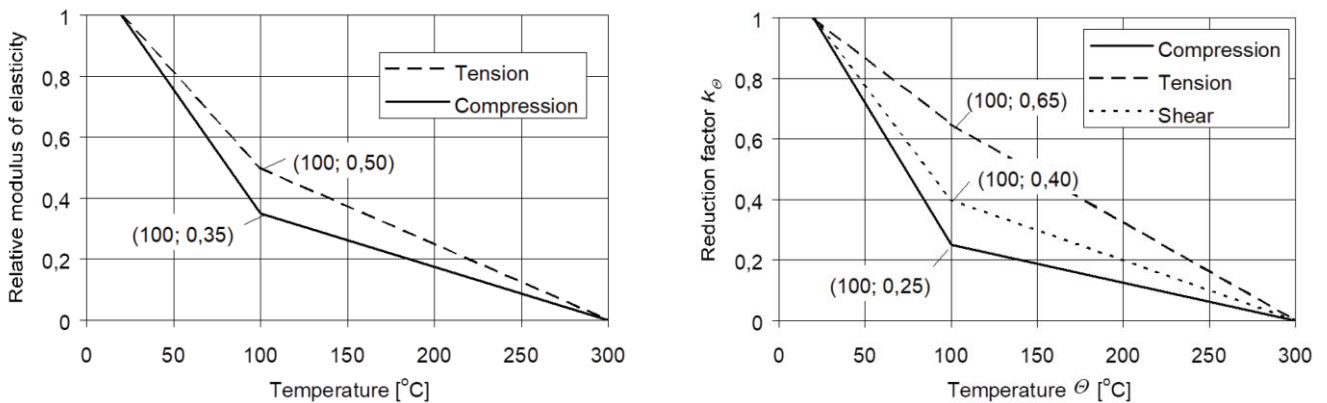

Figure 48: Influence of temperature on the mechanical properties of softwood. Left: Reduction of modulus of elasticity parallel to grain, Right: Reduction of strength parallel to grain (EN1995-1-2:2004, Figure B.4 and B.5 [22]).



For compression perpendicular to grain, the same reduction of strength may be applied as for compression parallel to grain.

For shear with both stress components perpendicular to grain (rolling shear), the same reduction of strength may be applied as for compression parallel to grain.

The resistance to fire behaviour of wood products is highly predictable and can be calculated according to the structural fire design specifications of Eurocode 5.

11.1 Reaction to fire

Reaction to fire requirements are specified for wood surfaces to control the risk of flame spread in buildings. They set boundary conditions for the use of visible wood in claddings and structures. In some cases fire retardant treatments or sprinkler systems can allow more visible wood structures to be used in architectural design.

LVL G by Stora Enso in relation to its reaction to fire behaviour is classified as D-s1, d0 according to the European classification system defined in EN 13501-1:2018 [23].

The format of the reaction to fire classification is:

Fire behaviour		Smoke production			Flaming droplets	
D	-	S	1	,	d	0

This classification [24] is valid for the following end use applications:

- with or without an air gap between the product and a wood based product or any substrate of classes A1 and A2-s1,d0 with density of at least 337,5 kg/m³

The reaction to fire classification can be improved by fire retardant treatments or with inorganic surface laminates which can delay the combustion of derived timber products and reduce the subsequent release of energy. Depending on the retardant used, the product can be classified up to a class B-s1,d0, which is the highest class for combustible materials.

- Euro classes: A1, A2, B, C, D, E, F (Criteria: ignitability, flame propagation, heat release)
- Smoke classes: s1, s2, s3 (s1 => lowest smoke production)
- Burning droplets classes: d0, d1, d2 (d0 => no flaming droplets)

Fire retardant treatment can be applied on LVL G by Stora Enso as an additional service.

11.2 Resistance to fire of LVL G based on calculations according to EN 1995-1-2:2011 (Eurocode 5)

For resistance to fire, load-bearing performance (class R) can be determined in accordance with EN 1995-1-2 as a part of design of works.

For the required time of fire exposure *t*, it must be demonstrated that:

$$E_{d,fi} \leq R_{d,t,fi} \tag{Eq 198}$$

where:

- E_{d,fi}* is the design value of actions for the fire situation (= load effect)
(With materials other than wood, thermal expansion must also be taken into account.)
- R_{d,t,fi}* is the corresponding design resistance in the fire situation (= resistance)



11.3 Verification method for actions in the fire situation according to EN 1995-1-2:2011

The design value for actions in the fire situation should be determined for time $t = 0$ using combination factors $\psi_{1,1}$ or $\psi_{2,1}$ according to EN 1991-1-2:2002, clause 4.3.1. (See also EN 1990-1-1, clause 6.4.3.3.)

$$E_{d,A} = \sum G_{k,j} + "P" + "A_d" + "Q_{k,1} \cdot (\psi_{1,1} \text{ or } \psi_{2,1})" + " \sum \psi_{2,1} \cdot Q_{k,i} \tag{Eq 199}$$

where

- $G_{k,j}$ is the characteristic value of a permanent action j
- P is the decisive representative value of a pre-load
- A_d is the design value of an exceptional action
- $Q_{k,1}$ is the characteristic value of a decisive variable action 1
- $Q_{k,i}$ is the characteristic value of a decisive variable action i
- ψ_1 is the combination factor for frequent values of variable actions
- ψ_2 is the combination factor for quasi-permanent values of variable actions

It is up to the engineer to choose/use $\psi_{1,1}$ or $\psi_{2,1}$.

For simplicity, the design value for actions in the fire situation $E_{d,fi}$ from the calculation of the design value for actions at normal temperature E_d may be determined thus:

$$E_{d,fi} = \eta_{fi} \cdot E_d \tag{Eq 200}$$

Where

- $E_{d,fi}$ is the design value of actions for the fire situation
- η_{fi} is the reduction factor for the design value of actions in the fire situation
- E_d is the design value for actions at normal temperature for the fundamental combination of actions

For the load combination in accordance with EN 1990-1-1, the reduction factor η_{fi} should be taken as follows, whereby the smallest value is given by the following two equations:

$$\eta_{fi} = \frac{G_k + \psi_{fi} \cdot Q_{k,1}}{\gamma_G \cdot G_k + \gamma_{Q,1} \cdot Q_{k,1}}$$

Eq 201

$$\eta_{fi} = \frac{G_k + \psi_{fi} \cdot Q_{k,1}}{\xi \cdot \gamma_G \cdot G_k + \gamma_{Q,1} \cdot Q_{k,1}}$$

Eq 202

where

- G_k is the characteristic value of a permanent action
- $Q_{k,1}$ is the characteristic value of the leading variable action 1
- γ_G is the partial safety factor for permanent actions
- $\gamma_{Q,1}$ is the partial safety factor for the leading variable action
- ψ_{fi} is the combination factor for frequent values of variable actions in the fire situation, given either by $\psi_{1,1}$ or $\psi_{2,1}$, see EN 1991-1-1
- ξ is a reduction factor for unfavourable permanent actions G (see EN 1990-1-1, clause A.1.3.1)

As a simplification, for the reduction factor η_{fi} , as an alternative to the above equation, the recommended value is $\eta_{fi} = 0.6$ according to EN 1995-1-2:2011, clause 2.4.2. Exceptions here are areas with larger imposed loads according to category E given in EN 1991-1-2:2002, where the recommended value is $\eta_{fi} = 0.7$.

When comparing the options for determining actions, it is clear that the simplified assumption with the action $E_{d,fi}$ results in a greater load than the actions in the exceptional design situation $E_{d,A}$.



11.4 Verification method for mechanical resistance in the fire situation according to EN 1995-1-2:2011

For verification of mechanical resistance, the design values of strength and stiffness properties shall be determined from:

$$f_{d,fi} = K_{mod,fi} \cdot \frac{f_{20}}{\gamma_{M,fi}} \quad \text{Eq 203}$$

Where

$f_{d,fi}$	is the design value of strength in fire
$K_{mod,fi}$	is the modification factor in the fire situation for the reduced cross-section method: $K_{mod,fi} = 1,0$ (as per EN 1995-1-2) in most cases, except when the method of annex C of EN 1995-1-2 is used
f_{20}	is the 20% fractile value of a strength property at normal temperature; $f_{20} = K_{fi} \cdot f_k$
f_k	is the 5% fractile value of a strength property
K_{fi}	is the coefficient for converting 5% to 20% fractile values; K_{fi} for LVL = 1,10 (as per EN 1995-1-2)
$\gamma_{M,fi}$	is the partial safety factor for timber in fire $\gamma_{M,fi} = 1,0$ (as per EN 1995-1-2) Information on national choice may be found in the national annex.

For the calculation in the fire situation, instead of the 5% fractile values, the 20% fractiles are used. The reason for this assumption lies in the extremely low probability of occurrence of a fully developed fire during the lifetime of a supporting structure, and does not depend on the material.

For stability calculations, the characteristic values of stiffness properties at normal temperature are used.

11.5 Charring rates of LVL G by Stora Enso

There are two different types of charring rates β_0 and β_n . For panels and wide cross sections one-dimensional charring rate β_0 is used in the calculations. This is also used as the basis value in some more advanced calculation methods.

When the characteristic density of LVL is $\rho_k \geq 480 \text{ kg/m}^3$, under standard fire exposure, the one-dimensional charring rate β_0 is 0,65 mm/min and the notional design charring rate β_n is 0,70 mm/min.

The charring rates shall be used in the simplified bilinear model of clause 3.4.3 (Surface of beams and columns initially protected from fire exposure) of EN 1995-1-2:2004 including the tabulated multiplication factors of the clause to determine the charring depth according to time requirements, considering clause 4.2.2 (Residual cross section method) of EN 1995-1-2:2004. For the application of the simplified bilinear method, it should be highlighted that the fire exposed lamella shall be considered as a protective cladding of the subsequent lamella. Analogously, this procedure also applies to beams, columns, walls and floors/roofs elements.

During exposure to fire and to the resulting effect of temperature on the LVL G cross-section, the use of polyurethane (PUR) adhesives between individual layers can lead to softening. A possible consequence of this may be that small sections of the heat-insulating char layer fall off, and the protective function of this layer may be lost at certain points. Therefore, in the case of vertical members, ceiling elements and other horizontal members, possible delaminations must be taken into account, and, for the subsequent fire-exposed layers, it is necessary to mathematically estimate an increased charring rate until the formation of a new 25 mm-thick char layer (see Figure 49 and Figure 50) .

Additional instructions of applying the clauses 3.4.3 and 4.2.2 of EN1995-1-2:2004 have been applied for LVL G (see LVL G European Technical Assessment [1]) .



11.5.1 Design value of charring rates for LVL G on surfaces which are unprotected throughout the duration of the fire

The following charring rates for LVL G by Stora Enso may be used for the calculation of the fire resistance of constructions with different loads and/or layer thicknesses according to EN 1995-1-2 (with reference to the respective national annex).

Ceiling (only face), roof (only face), and flatwise beam elements (horizontal members used in flatwise direction):

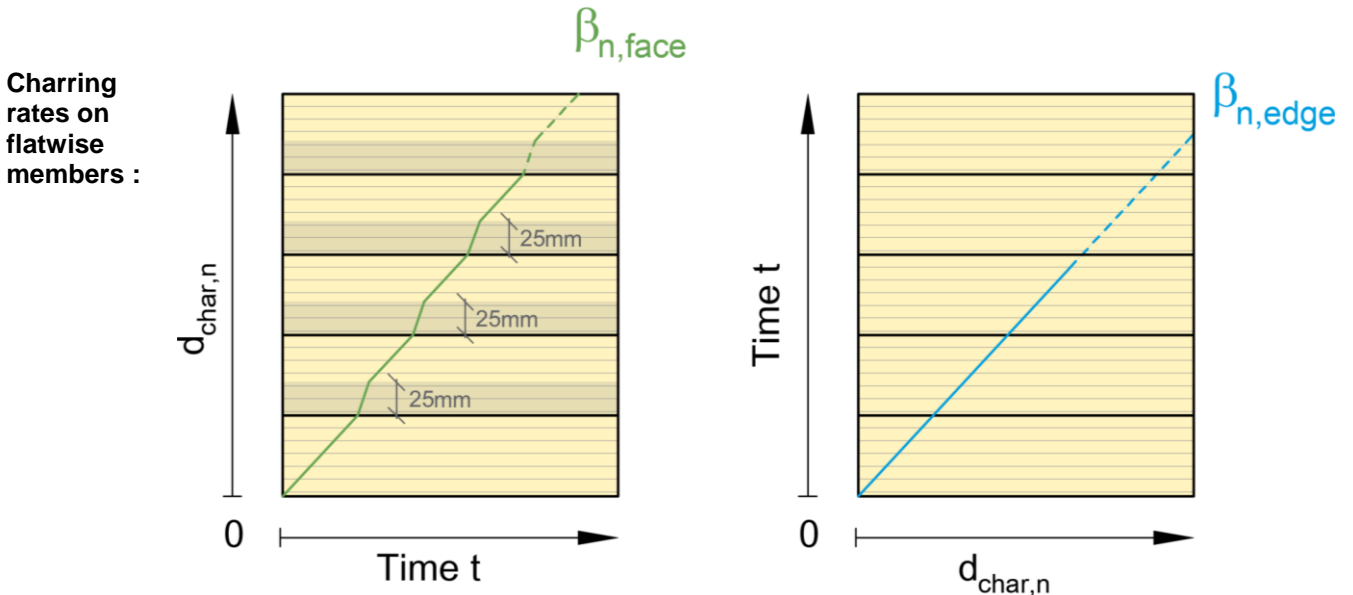

Figure 49: Variation of LVL G charring depth as a function of time in face direction (left) and in edge direction (right).

Wall (only face), column and edgewise beam elements (vertical components used in edgewise direction):

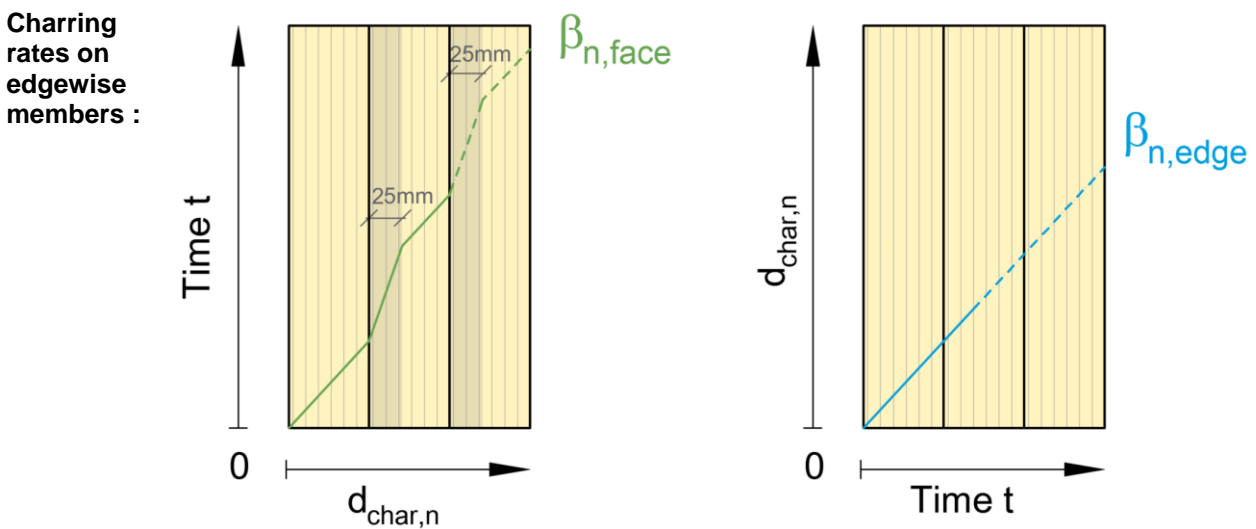

Figure 50: Variation of LVL G charring depth as a function of time in face direction (left) and in edge direction (right). (No char layer fall off in this direction)

DESIGN MANUAL

Dec-20

One side exposure:

- $\beta_0 = 0.65 \text{ mm/min}$, if only one layer is affected by exposure to fire (on one side: edge or face).
- $\beta_{0,edge} = 0.65 \text{ mm/min}$ for the edge side
- $\beta_{0,face} = 1.3 \text{ mm/min}$ for the face side of any additional layers affected by exposure to fire until charring or the formation of a 25 mm-thick char layer.

Thereafter, a charring rate of $\beta_{0,face} = 0.65 \text{ mm/min}$ can be applied up to the next glue line bonded joint.

Several sides exposure:

- $\beta_n = 0.70 \text{ mm/min}$, if several sides of the section are affected by exposure to fire (on the face and edge sides).
- $\beta_{n,edge} = 0.70 \text{ mm/min}$ for the edge side.
- $\beta_{n,face} = 1.40 \text{ mm/min}$ for the face side of any additional layers affected by exposure to fire until charring or the formation of a 25 mm-thick char layer.

Thereafter, a charring rate of $\beta_{n,face} = 0.70 \text{ mm/min}$ can be applied up to the next glue line bonded joint.

An advantage with LVL G by Stora Enso is that the lamination thicknesses range from 30mm to 69mm, so the accelerated charring rate in face direction will not occur as many times.

E.g. with lamella thicknesses 30/36/42/48/60mm:

Without taking the zero strength layer d_0

$$\frac{30\text{mm}}{0,7\text{mm/min}} = 42,8\text{min} \quad \rightarrow \text{No accelerated charring rate until 42,8min}$$

$$\frac{36\text{mm}}{0,7\text{mm/min}} = 51,4\text{min} \quad \rightarrow \text{No accelerated charring rate until 51,4min}$$

$$\frac{42\text{mm}}{0,7\text{mm/min}} = 60,0\text{min} \quad \rightarrow \text{No accelerated charring rate until 60,0min}$$

$$\frac{48\text{mm}}{0,7\text{mm/min}} = 68,5\text{min} \quad \rightarrow \text{No accelerated charring rate until 68,5min}$$

$$\frac{60\text{mm}}{0,7\text{mm/min}} = 85,7\text{min} \quad \rightarrow \text{No accelerated charring rate until 85,7min}$$



storaenso

11.5.2 Design value of charring rates for LVL G on surfaces which are initially protected from exposure to fire by gypsum plasterboard

Fire resistance rating of components is determined during exposure to fire on the inside of a room predominantly by interior cladding. To increase the fire resistance of structures such as wall, ceiling, roof or beam elements, plaster building materials/gypsum plasterboards are generally used as, even if they are not very thick, they provide effective protection.

Effective protection is based particularly on the combined crystal water in the panels' gypsum core which has a concentration of approx. 20%. Energy is consumed by the evaporation of this crystal water, and a protective steam curtain is also formed on the fire-exposed side of the component. In addition to delaying the spread of fire, the dehydrated gypsum layer also acts as insulation through the declining thermal conductivity. Fire protection plasterboard also contains glass fibre which reinforces the gypsum core and ensures structural cohesion when exposed to fire.

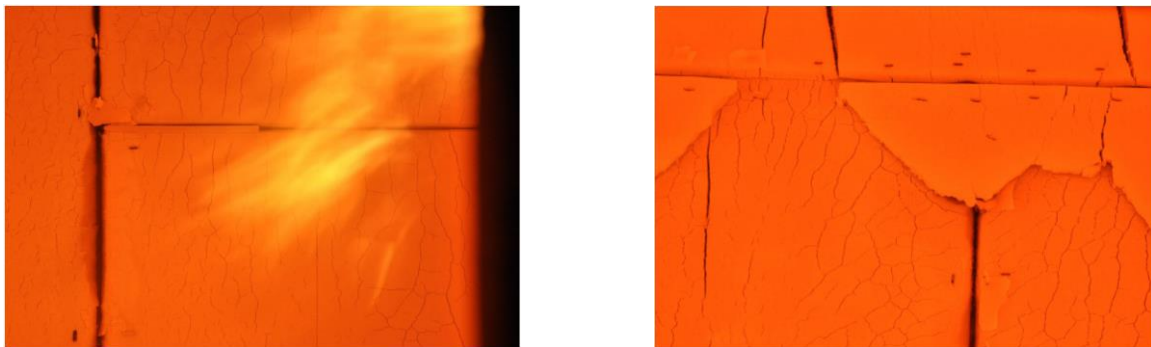

Figure 51: Two-ply fire protection plasterboard cladding exposed to fire during a large-scale fire test

Figure 51 illustrates the behaviour of fire protection plasterboard when exposed to fire; in this case there are two layers of cladding.

As it can be seen, after crazing and detaching of the char layer, as time progresses, large gaps appear between the joints, the joint plaster compound fails and the first section of the first plasterboard layer falls off. If larger panel sections fall away from the first layer, crazing also occurs in the second layer. After gaps appear in this layer's joints, the flames spread through the increasing gaps in the joints towards the underlying timber member which leads to the production and emission of wood gas. Charring starts on the initially protected LVL G element.

In the case of initially protected members, the time of start of charring behind the protective layer or cladding t_{ch} and the failure time of the protective cladding t_f is essential. According to EN 1995-1-2:2011, the following must be taken into account:

- The start of charring is delayed until time t_{ch} ;
- Charring can occur before failure of the fire protective cladding, however until the failure time t_f , the charring rate is lower than the value according to [22], table 3.1;
- The charring rate after the failure time t_f of the fire protective cladding until time t_a is greater than the value according to [22], table 3.1;
- The charring rate from time t_a , where the charring depth corresponds to the lowest value – either the charring depth of a similar component without fire protective cladding or 25 mm – again takes the values according to [22], table 3.1.

The following diagrams from EN 1995-1-2 [22] are provided to support the understanding of the points above (Those diagrams might be updated in the next version of the EN 1995-1-2):

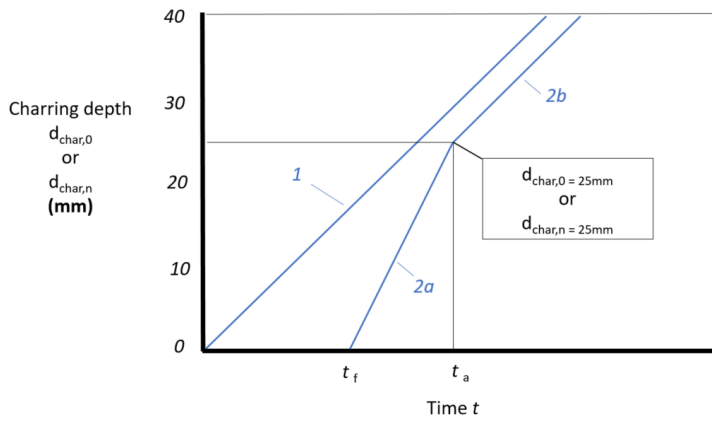

Figure 52: Charring depth depending on the time for $t_{ch} = t_f$ and a charring depth of 25 mm at time t_a

- 1: Relationship for components which are unprotected throughout the time of fire exposure with the notional charring rate β_n (or β_0)

- 2: Relationship for initially protected components after failure of the fire protective cladding

2a: After the fire protective cladding has fallen off, charring starts at an increased rate

2b: After the charring depth exceeds 25 mm or the time t_a is exceeded, the charring rate reduces to the normal rate.

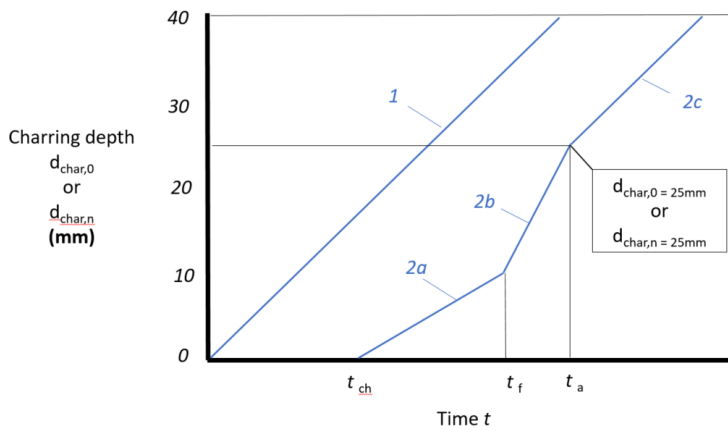

Figure 53: Charring depth depending on the time for $t_{ch} < t_f$

- 1: Relationship for components which are unprotected throughout the time of fire exposure with the notional charring rate β_n (or β_0)

- 2: Relationship for initially protected components on which charring starts before failure of the fire protective cladding

2a: Charring starts at t_{ch} , at a reduced rate for as long as the fire protective cladding remains intact

2b: After the fire protective cladding falls off, charring starts at an increased rate

2c: After the charring depth exceeds 25 mm or the time t_a is exceeded, the charring rate reduces to the normal value.

Charring rates for initially protected components

For time $t_{ch} \leq t \leq t_f$, the charring rates given in EN 1995-1-2 [22], table 3.1 should be multiplied by a factor k_2 ; for single layer gypsum plasterboard, type F, this is calculated as:

$$k_2 = 1 - 0,018 \cdot h_p \tag{Eq 204}$$

where:

h_p is the thickness of the layer in mm

For several layers of gypsum plasterboard, type F, h_p should be taken as the thickness of the inner layer.

If the timber component is protected by rock wool batts (thickness: ≥ 20 mm, bulk density: ≥ 26 kg/m³, melting point: ≥ 1000 °C), the factor k_2 may be taken from Table 14. For thicknesses between 20 and 45 mm, linear interpolation may be applied.



Table 14: values of k_2 for timber components protected by rock fibre batts

Thickness h_{ins} mm	k_2
20	1
≥ 45	0,6

For the stage after failure of the fire protective cladding given by $t_f \leq t \leq t_a$, according to [22], the charring rates given in EN 1995-1-2, table 3.1 should be multiplied by a post-protection factor $k_3 = 2$.

For $t \geq t_a$, the charring rates should be applied without multiplication by the factor k_3 .

The time limit t_a (see Figure 52) should for $t_{ch} = t_f$, in accordance with [22], be taken as:

$$t_a = \min \left\{ \begin{array}{l} 2 \cdot t_f \\ \frac{25}{k_3 \cdot \beta_n} + t_f \end{array} \right. \quad \text{Eq 205}$$

Or for $t_{ch} < t_f$: (see Figure 53)

$$t_a = \frac{25 - (t_f - t_{ch}) \cdot k_2 \cdot \beta_n}{k_3 \cdot \beta_n} + t_f \quad \text{Eq 206}$$

where:

β_n is the design value of the notional charring rate in mm/min.
(In the case of one-dimensional charring, β_n is replaced by β_0 .)

11.5.3 Start of charring on initially protected components

- Single layer gypsum plasterboard, type A, F or H:

For claddings consisting of one layer of gypsum plasterboard, type A, F or H, according to EN 520, outside of joints or at locations adjacent to filled joints, or unfilled gaps with a width of 2 mm or less, in accordance with [22], the start of charring t_{ch} should be taken as:

$$t_{ch} = 2,8 \cdot h_p - 14 \quad \text{Eq 207}$$

In locations adjacent to joints with unfilled gaps with a width of more than 2 mm, the time of start of charring should be calculated as:

$$t_{ch} = 2,8 \cdot h_p - 23 \quad \text{Eq 208}$$

where:

t_{ch} is the time of start of charring of a protected component in minutes
 h_p is the thickness of the fire protective cladding in mm

- Two-layer gypsum plasterboard, type A or H:

For claddings consisting of two layers of gypsum plasterboard, type A or H in accordance with EN 520, according to [22], the time of start of charring t_{ch} should be determined according to the equations above, where the thickness h_p is taken as the thickness of the outer layer and 50% of the thickness of the inner layer. This is subject to the condition that the spacing of fasteners in the inner layer is not greater than the spacing of fasteners in the outer layer.



- **Claddings consisting of two layers of gypsum plasterboard, type F:**

For claddings consisting of two layers of gypsum plasterboard, type F in accordance with EN 520, according to [22], the time of start of charring t_{ch} should be determined according to the equations above, where the thickness h_p is taken as the thickness of the outer layer and 80% of the thickness of the inner layer. This is subject to the condition that the spacing of fasteners in the inner layer is not greater than the spacing of fasteners in the outer layer.

- **Beams protected by rock fibre batts (Cavity insulation material):**

If the timber component is protected by rock fibre batts (thickness: ≥ 20 mm, bulk density: ≥ 26 kg/m³, melting point: ≥ 1000 °C), for the time of start of charring t_{ch} , the following equation must also be taken into account:

$$t_{ch} = 0,07 \cdot (h_{ins} - 20) \cdot \sqrt{\rho_{ins}} \quad \text{Eq 209}$$

where:

t_{ch}	is the time until the start of charring of a protected component in minutes
h_{ins}	is the insulation material thickness in mm
ρ_{ins}	is the insulation material bulk density in kg/m ³

11.5.4 Failure time of fire protective claddings

The charring or mechanical degradation of the cladding material, the spacing of, and distances between, fasteners and/or a possible insufficient penetration length of fasteners into the uncharred cross-section could be responsible for the failure of the fire protective cladding.

- **Cladding consisting of gypsum plasterboard, type A or H:**

For gypsum plasterboard, type A or H in accordance with EN 520, according to [25], the failure time t_f is equal to the time at the start of charring t_{ch} .

For gypsum plasterboard, type A or H, after the start of charring and after the cladding simultaneously falls off, charring occurs at an increased rate until time t_a . After formation of a 25 mm-thick char layer, the charring rate reduces to the normal rate – see Figure 52.

$$t_f = t_{ch} \quad \text{Eq 210}$$

- **Cladding consisting of gypsum plasterboard, type F:**

However, in the case of gypsum plasterboard, type F or fire protection plasterboard, according to [22], there is less charring from the start of charring t_{ch} to the time t_f . Until the subsequent formation of a 25 mm-thick char layer, charring occurs at double the rate, after which, the charring rate reduces to the normal rate – see Figure 53.

EN 1995-1-2:2011 [22] does not provide any information regarding the failure time of gypsum plasterboard, type F or fire protection plasterboard.

The failure time of claddings made of gypsum plasterboards type F (according to EN 520) should be determined with respect to the thermal degradation of the cladding and with respect to pull-out failure of fasteners due to insufficient penetration length into the uncharred wood.

The failure time due to thermal degradation of the cladding should be assessed on the basis of tests or may be taken from a National Annex to EN 1995-1-2:2011 [22] containing all Nationally Determined Parameters to be used for the design of buildings and civil engineering works to be constructed in the relevant country. (According to [22], more information on test methods is given in EN 1363-1, EN 1365-1 and EN 1365-2.)



DESIGN MANUAL

Dec-20

According to ÖNORM B 1995-1-2:2011 (Austrian national specifications), the failure times t_f for cladding consisting of fire protection plasterboard in accordance with ÖNORM B 3410 or gypsum plasterboards, type DF according to EN 520 and gypsum fibreboard GF-C1-W2 according to EN 15283-2 can be determined as follows:

Wall components:

$$t_f = 2,2 \cdot h_p + 4 \quad \text{Eq 211}$$

Ceiling components:

$$t_f = 1,4 \cdot h_p + 6 \quad \text{Eq 212}$$

where:

t_f	is the failure time of the fire protective cladding in minutes
h_p	is the thickness of the fire protective cladding in mm

In determining the failure time of multiple-layer cladding consisting of gypsum plasterboard, type F, the rules specified in section 11.5.3 apply correspondingly, according to which, the thickness h_p corresponds to the thickness of the outer layer and to 80% of the thickness of the inner layer.

■ Penetration length of fasteners for gypsum plasterboard

In addition to thermal degradation of the cladding material, the fire protective cladding can also fall off due to the pull-out failure of fasteners.

According to [22], the required minimum length of the fasteners should also be determined in order to eliminate the fact that pull-out of the fasteners is a relevant factor for the failure of the fire protective cladding.

The minimum penetration length of the fastener l_a into the uncharred cross-section should be taken as 10 mm at least. The required penetration length of the fastener $l_{af,req}$ is calculated as follows:

$$l_{f,req} = h_p + d_{char,0} + l_a \quad \text{Eq 213}$$

where:

h_p	is the panel thickness in mm
$d_{char,0}$	is the charring depth in the timber component
l_a	is the minimum penetration length of the fastener into the uncharred wood

For more information on cladding fasteners/penetration lengths, see [22], section 7.1.2.

11.6 Determining the load-bearing capacity (R) of LVL G elements according to EN 1995-1-2:2011

When determining the load-bearing capacity (R) of timber components exposed to fire, or when calculating cross sectional values, in addition to determining the charring area, the underlying area affected by temperature must also be taken into account because the wood's strength and stiffness properties decrease as the temperature rises.

As an alternative to the calculation option specified in EN 1995-1-2, annex B, the cross-sectional values can also be calculated using two simplified methods. We recommend the first method:

■ Reduced cross-section method

For verification in the fire situation, this method uses a reduced cross-section or residual cross-section, calculated on the basis of increased charring (roundings or corner charring), and an additional area affected by temperature (reduction of mechanical properties due to the effect of temperature).

■ Reduced properties method

As an alternative to the reduced cross-section method – calculated with charring rate and corner charring, this method takes into account the reduction of mechanical properties depending on the type of load and cross-section.

The verification of load-bearing capacity in the fire situation is performed for LVL G on the basis of the reduced cross-section method.



storaenso

11.6.1 Reduced cross-section method

The cross-section which is reduced by the charring depth is further reduced by removing a layer with zero strength and stiffness $k_0 \cdot d_0$. Thus, the residual cross-section is calculated by deducting the effective charring depth d_{ef} from the original cross-section as presented in Figure 54.

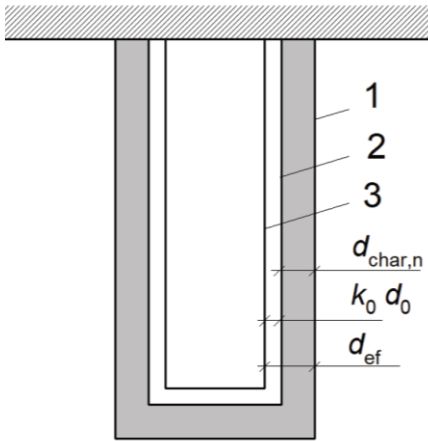

Figure 54: Definition of residual cross-section and effective cross-section.

1. Initial surface of member,
2. Border of residual cross-section,
3. Border of effective cross-section.

$$d_{ef} = d_{char} + k_0 \cdot d_0$$

Eq 214

d_{ef} is the effective charring depth
 d_{char} is the notional design charring depth:

LVL G panels	LVL G columns & beams
$d_{char,LVL G} = d_{char,0} = \beta_0 \cdot t$	$d_{char,LVL G} = d_{char,n} = \beta_n \cdot t$

β_0 is the design value of the one-dimensional charring rate under standard fire exposure
 β_n is the design notional charring rate under standard fire exposure
 t is the time under fire exposure

k_0	LVL G panels	LVL G columns & beams
	$k_0 = 1,0$	$t < 20 \text{ min.}: k_0 = t / 20$ $t \geq 20 \text{ min.}: k_0 = 1.0$

d_0 is the depth of a layer (close to the char line) with assumed zero strength and stiffness.
 $d_0 = 7 \text{ mm}$

Note: The value d_0 of 7 mm (for the simplified calculation method of the reduced cross-section method) is currently being discussed by scientists around the world, however no unified opinion has been established. Possible national regulations on d_0 must be taken into account.

For protected surfaces with a start of charring time of $t_{ch} > 20$ minutes, k_0 is assumed to vary linearly from 0 to 1 during the time interval from $t = 0$ to $t = t_{ch}$, see Figure 56(b). For protected surfaces with $t_{ch} \leq 20$ minutes k_0 is $t/20$.

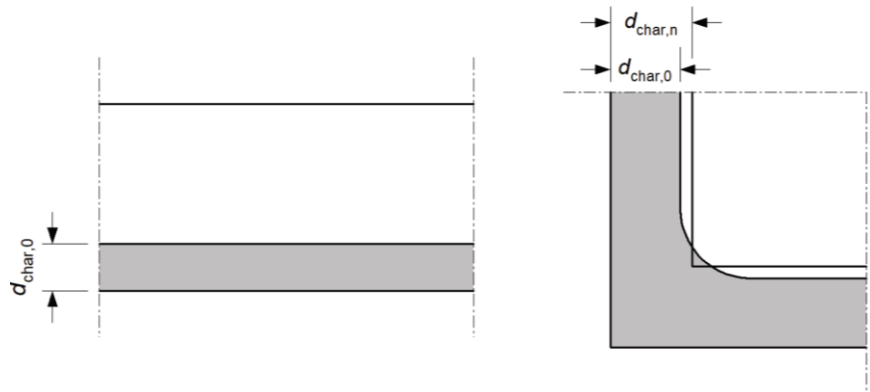

Figure 55: Left: One-dimensional charring of panel or wide cross section when fire exposure is below on one side,

Right: Charring depth $d_{char,0}$ for one-dimensional charring and notional charring depth $d_{char,n}$ which takes into account the rounding of corners.



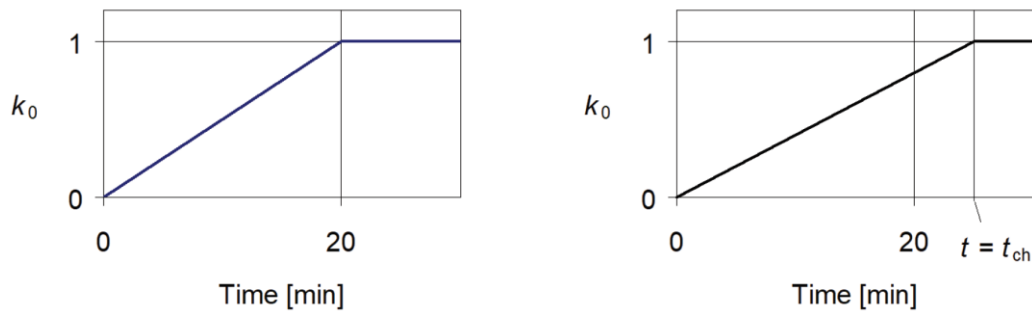

Figure 56:(a) Variation of k_0 for unprotected members and protected members where $t_{ch} \leq 20$ minutes and (b) for protected members where $t_{ch} > 20$ minutes.

For timber surfaces facing a void cavity in a floor or wall assembly (normally the wide sides of a stud or a joist), the following applies:

- Where the fire protective cladding consists of one or two layers of gypsum plasterboard type A, wood panelling or wood-based panels, at the time of failure t_f of the cladding, k_0 should be taken as 0,3. Thereafter k_0 should be assumed to increase linearly to 1,0 during the following 15 minutes;
- Where the fire protective cladding consists of one or two layers of gypsum plasterboard type F, at the time of start of charring t_{ch} , k_0 is 1. For times $t < t_{ch}$, linear interpolation should be applied, see Figure 56 (b).

The effective (reduced) cross section should be used for the calculation of the stiffness and fire resistance of an LVL G member.

Note: The effective cross section method is recommended. However, depending on the National Annex, the reduced properties method of Eurocode 5 may also be used.

When verifying the load-bearing capacity in the fire situation of LVL G by Stora Enso components, the following must be observed:

- Charring on both sides must be taken into account on load-bearing elements with no separating function.
- Possible additional, eccentric load applications due to one-sided charring must be taken into account particularly on thinner LVL elements.
- Residual cross-sections of layers ≤ 3 mm are not used in the remaining calculations. (This assumption takes into account the generally non-linear nature of the char line.)

11.7 Structural analysis in fire

According to Eurocode 5, clause 4.3 Simplified rules for analysis of structural members and components, compression perpendicular to the grain and shear resistance may be disregarded.

The remaining calculation steps and verifications are performed in the same way as the cold calculations.



12. Seismic evaluation

The product is only intended to be used subject to static or quasi-static actions. It is intended to be used in seismic areas. The behavior factor of LVL G is limited to non-dissipative or low-dissipative structures ($q \leq 1,5$), defined according to Eurocode 8 (EN 1998-1:2004 clauses 1.5.2 and 8.1.3 b). In case of seismic actions, the ductile behaviour of the final works will be guaranteed, if requested, by joints and connections appropriately designed and realized according to the relevant national rules on design and execution of works.

13. Installation

Stora Enso LVL G shall be installed by appropriately qualified personnel, following the installation plan for each project.

13.1 Protection against temporary moisture exposure of structural LVL G

The product shall be protected against moisture during installation.

Exposure to rain, splashing as well as water convection from other structures shall be avoided. The designer must pay attention to the details of the construction to ensure that no water pockets will be formed. The product may be exposed to weather for a short period during installation. During the erection of a building, structural LVL products and elements, which are structurally glued from LVL components, have good resistance to temporary exposure to water without damage or decay. This requires, however, that it is ensured that the products can afterwards dry to the desired moisture content before the structural envelope is closed. The integrity of the glue bonding is maintained according to the assigned service class throughout the expected life of the structure.

LVL products swell when the moisture content increases, and shrink when the moisture content decreases. A part of the swelling is permanent and the extent of these dimensional changes depends on the grain direction. Wetting can cause permanent deformations and impair the visual appearance of surface veneers, such as colour changes due to water staining, surface cracks and falling knots due to drying shrinkage after wetting.

Joints with mechanical connectors, such as bolted connections, may become loose due to swelling and shrinking cycles. Drying shrinkage after severe wetting may cause cracking, which often reduces the load-bearing capacity of dowel-type connections, notched beams and beams with holes.

Outdoor use or use in high relative humidity conditions may cause mould growth on the surface of LVL G products. During and after installation, if heaters are placed near columns and beams to help control moisture and improve working conditions, those should not blow warm dry air directly on the timber in order to avoid the extraction of the natural moisture from inside the LVL G section which would cause unexpected cracks on the edge surfaces.

13.2 Resistance against UV radiation

The product shall be protected against UV radiation when a storage is organised on the building site.

Like all wood products, non-treated surfaces of LVL G will slowly fade to grey due to the action of UV radiation from the sun. This greying does not affect the strength properties.

If this natural greying is not desired, an adequately pigmented coating system or a coating containing special additives must be applied.

13.3 Recommendations on packaging, transport and storage maintenance, replacement and repair

Concerning product packaging, transport, storage, maintenance, replacement and repair it is the responsibility of Stora Enso to undertake the appropriate measures and to advise his clients on the transport, storage, maintenance, replacement and repair of the product as he considers necessary.

LVL G by Stora Enso shall be protected against harmful wetting during transport and storage and must not be lifted or stored in such a way that excessive deformation may cause damage to them.

Before the installation it shall be controlled that LVL G by Stora Enso members are not damaged during transport or storage. Damaged LVL G by Stora Enso shall be replaced by same ones.



14. Annexes

14.1 Lateral torsional buckling sensitivity analysis

Relative slenderness - Type B Edgewise

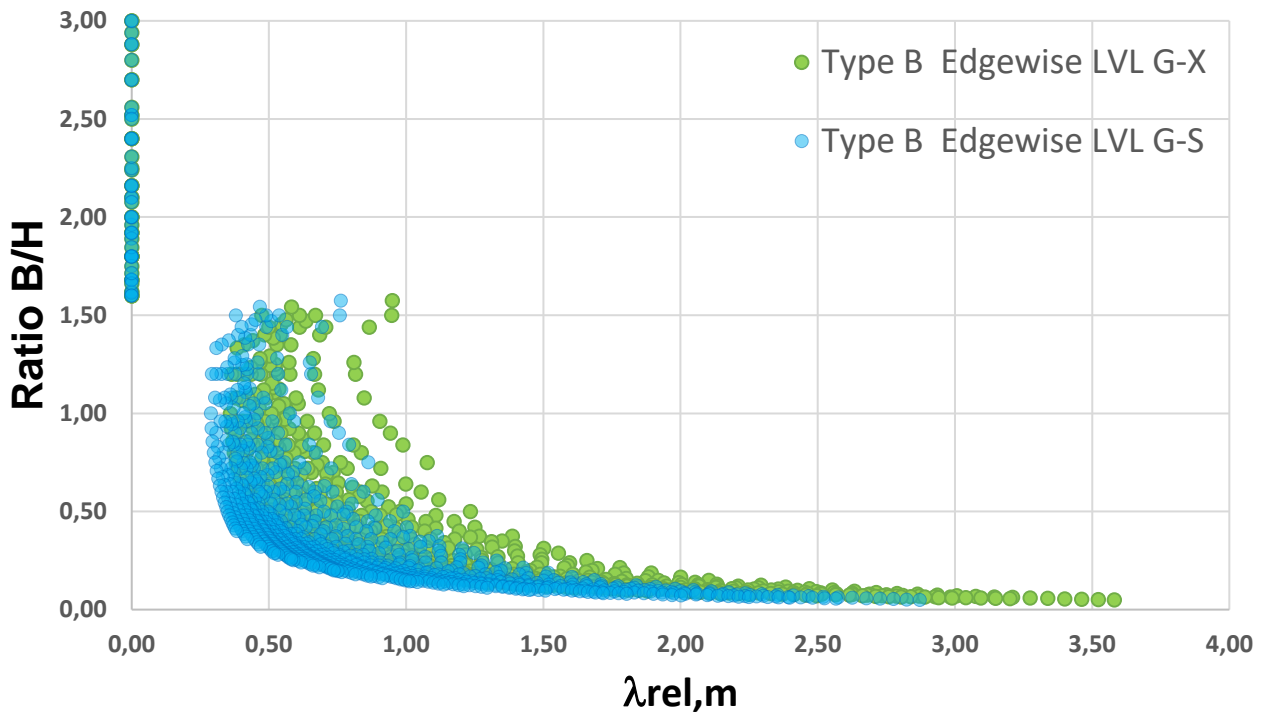

Relative slenderness - Type A Flatwise

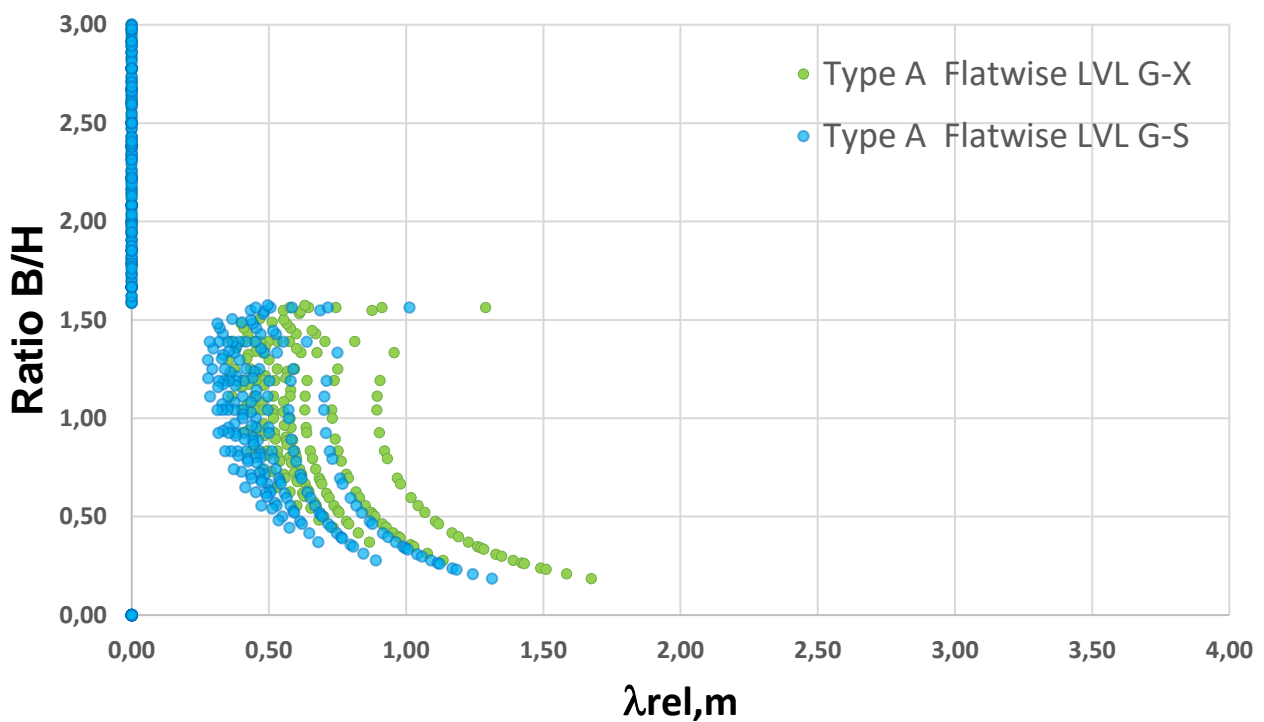

14.2 Multi axial stresses

Derivation of Hankinson equation

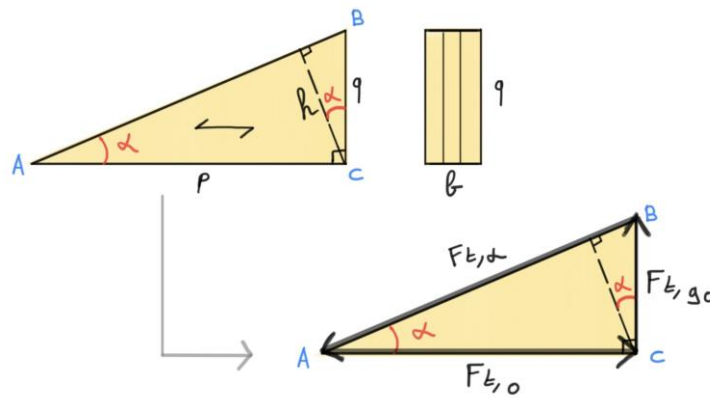
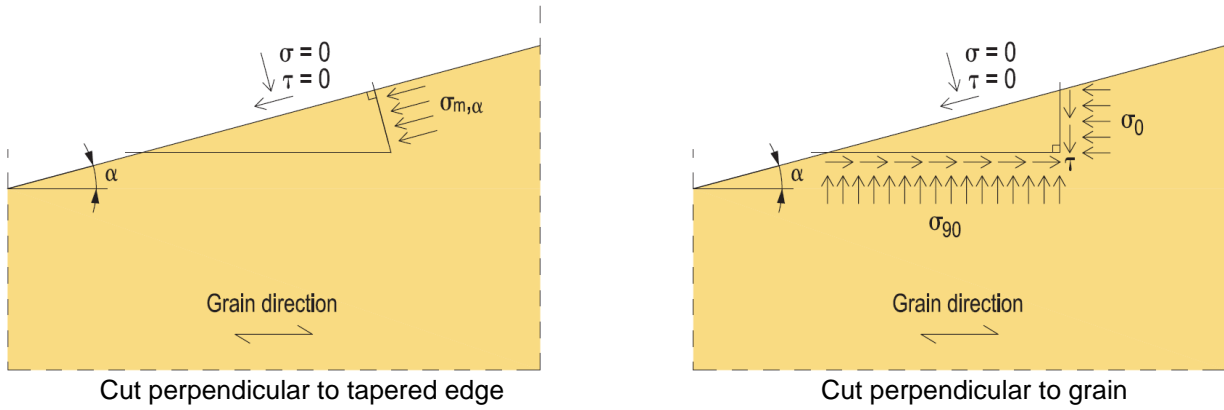

Trigonometric relationships:

$$\sin \alpha = \frac{h}{p} \rightarrow p = \frac{h}{\sin \alpha}$$

$$\cos \alpha = \frac{h}{q} \rightarrow q = \frac{h}{\cos \alpha}$$

$$\sin \alpha = \frac{F_{t,90}}{F_{t,\alpha}} \rightarrow F_{t,\alpha} = \frac{F_{t,90}}{\sin \alpha}$$

$$\cos \alpha = \frac{F_{t,0}}{F_{t,\alpha}} \rightarrow F_{t,\alpha} = \frac{F_{t,0}}{\cos \alpha}$$



DESIGN MANUAL

Dec-20

From forces to stresses:

$$\sigma_{t,0} = \frac{F_{t,0}}{b \cdot q} = \frac{F_{t,0} \cdot \cos \alpha}{b \cdot h} \quad \text{Eq 215}$$

$$F_{t,0} = \frac{\sigma_{t,0} \cdot b \cdot h}{\cos \alpha}$$

$$\sigma_{t,90} = \frac{F_{t,90}}{b \cdot p} = \frac{F_{t,90} \cdot \sin \alpha}{b \cdot h} \quad \text{Eq 216}$$

$$F_{t,90} = \frac{\sigma_{t,90} \cdot b \cdot h}{\sin \alpha}$$

$$\sigma_{t,\alpha} = \frac{F_{t,\alpha}}{b \cdot h} = \begin{cases} \frac{F_{t,0}}{\cos \alpha \cdot b \cdot h} \\ \frac{F_{t,90}}{\sin \alpha \cdot b \cdot h} \end{cases} \quad \begin{array}{l} \text{Eq 217} \\ \text{Eq 218} \end{array}$$

Failure criterion – assumption of a linear interaction without shear stresses:

$$\frac{\sigma_{t,0}}{f_{t,0}} + \frac{\sigma_{t,90}}{f_{t,90}} = 1 \quad \text{Eq 219}$$

Inserting Eq 215 in Eq 217

$$\sigma_{t,\alpha} = \frac{\sigma_{t,0} \cdot b \cdot h}{\cos \alpha} \cdot \frac{1}{\cos \alpha \cdot b \cdot h} = \frac{\sigma_{t,0}}{\cos^2 \alpha} \quad \text{Eq 220}$$

$$\sigma_{t,0} = \sigma_{t,\alpha} \cdot \cos^2 \alpha$$

Inserting Eq 216 in Eq 218

$$\sigma_{t,\alpha} = \frac{\sigma_{t,90} \cdot b \cdot h}{\sin \alpha} \cdot \frac{1}{\sin \alpha \cdot b \cdot h} = \frac{\sigma_{t,90}}{\sin^2 \alpha} \quad \text{Eq 221}$$

$$\sigma_{t,90} = \sigma_{t,\alpha} \cdot \sin^2 \alpha$$

Inserting Eq 220 +Eq 221 in Eq 219

$$\frac{\sigma_{t,\alpha} \cdot \cos^2 \alpha}{f_{t,0}} + \frac{\sigma_{t,\alpha} \cdot \sin^2 \alpha}{f_{t,90}} = 1$$

where $\sigma_{t,\alpha} = f_{t,\alpha}$

$$\frac{f_{t,\alpha} \cdot \cos^2 \alpha}{f_{t,0}} + \frac{f_{t,\alpha} \cdot \sin^2 \alpha}{f_{t,90}} = 1$$

$$f_{t,\alpha} = \frac{1}{\frac{\cos^2 \alpha}{f_{t,0}} + \frac{\sin^2 \alpha}{f_{t,90}}} \quad \text{Eq 222}$$

$$f_{t,\alpha} = \frac{f_{t,0} \cdot f_{t,90}}{\sin^2 \alpha \cdot f_{t,0} + \cos^2 \alpha \cdot f_{t,90}}$$



storaenso

Eq 222 is the so-called Hankinson equation. The derivation applies to compressive or tensile stress; namely the index “t” for tension can be replaced with the index “c” for compression. Accordingly, Eq 223 corresponds to the central expression in Eq 222 while the last expression is in EC 5 with the coefficient $k_{c,90}$ applied to $f_{c,90}$ additionally.

$$f_{c,\alpha} = \frac{f_{c,0} \cdot f_{c,90}}{f_{c,0} \cdot \sin^2 \alpha + f_{c,90} \cdot \cos^2 \alpha} \quad \text{Eq 223}$$

Extension with shear

The following expression is added

$$\tau = \frac{F_{t,0}}{p \cdot b} = \frac{F_{t,\alpha} \cdot \cos \alpha}{\frac{h}{\sin \alpha} \cdot b} = \frac{F_{t,\alpha} \cdot \cos \alpha \cdot \sin \alpha}{h \cdot b} \quad \text{Eq 224}$$

From forces to stresses:

$$\tau = \frac{(\sigma_{t,\alpha} \cdot b \cdot h) \cdot \cos \alpha \cdot \sin \alpha}{h \cdot b} = \sigma_{t,\alpha} \cdot \cos \alpha \cdot \sin \alpha \quad \text{Eq 225}$$

Failure criterion – assumption of a linear interaction with shear stresses:

Once again, assuming a linear interaction:

$$\frac{\sigma_{t,0}}{f_{t,0}} + \frac{\sigma_{t,90}}{f_{t,90}} + \frac{\tau}{f_v} = 1 \quad \text{Eq 226}$$

Inserting Eq 220 , Eq 221 and Eq 225

$$\frac{\sigma_{t,\alpha} \cdot \cos^2 \alpha}{f_{t,0}} + \frac{\sigma_{t,\alpha} \cdot \sin^2 \alpha}{f_{t,90}} + \frac{\sigma_{t,\alpha} \cdot \cos \alpha \cdot \sin \alpha}{f_v} = 1$$

where $\sigma_{t,\alpha} = f_{t,\alpha}$

$$\frac{f_{t,\alpha} \cdot \cos^2 \alpha}{f_{t,0}} + \frac{f_{t,\alpha} \cdot \sin^2 \alpha}{f_{t,90}} + \frac{f_{t,\alpha} \cdot \cos \alpha \cdot \sin \alpha}{f_v} = 1$$

$$f_{t,\alpha} = \frac{1}{\frac{\cos^2 \alpha}{f_{t,0}} + \frac{\sin^2 \alpha}{f_{t,90}} + \frac{\cos \alpha \cdot \sin \alpha}{f_v}}$$

$$f_{t,\alpha} = \frac{f_{t,0}}{\frac{f_{t,0} \cdot \cos \alpha \cdot \sin \alpha}{f_v} + \frac{f_{t,0} \cdot \sin^2 \alpha}{f_{t,90}} + \cos^2 \alpha} \quad \text{Eq 227}$$



14.3 Beams with tapered edge

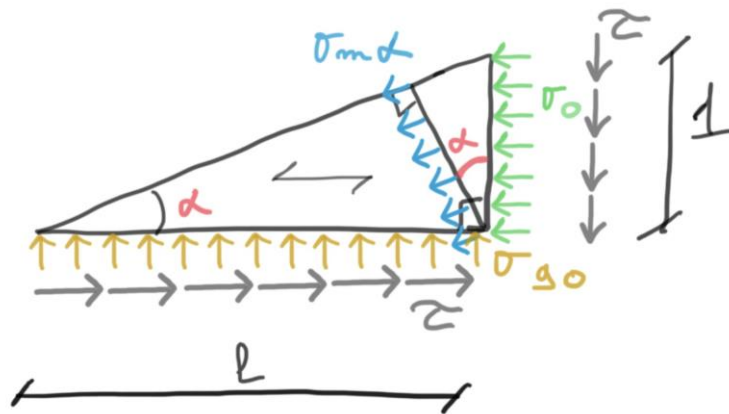
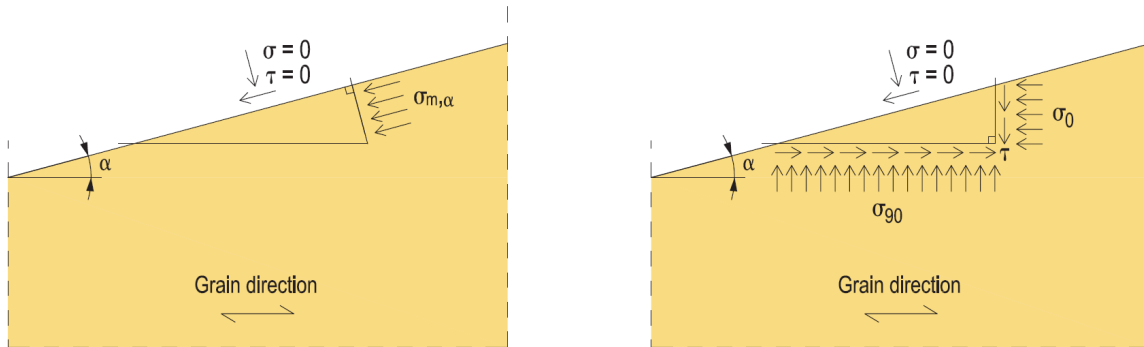

The equilibrium of forces in both horizontal and vertical directions results in:

$$l = \frac{1}{\tan \alpha} \quad \text{Eq 228}$$

$$\sum H = 0 = \sigma_0 \cdot 1 - \tau \cdot l \quad \text{Eq 229}$$

$$\tau = \sigma_0 \cdot \tan \alpha$$

$$\sum V = 0 = \sigma_{90} \cdot l - \tau \cdot 1 \quad \text{Eq 230}$$

$$\sigma_{90} = \tau \cdot \tan \alpha$$

Conclusion

$$\sigma_0 = \sigma_\alpha \cdot \cos^2 \alpha$$

$$\sigma_{90} = \sigma_\alpha \cdot \sin^2 \alpha = \frac{\sigma_0}{\cos^2 \alpha} \cdot \sin^2 \alpha = \sigma_0 \cdot \tan^2 \alpha$$

$$\tau = \sigma_\alpha \cdot \cos \alpha \cdot \sin \alpha = \sigma_0 \cdot \tan \alpha$$



References

- [1] Eurofins Expert Services Oy, "LVL G by Stora Enso- ETA 20/0291," 2020.
- [2] VTT Expert Services, "VTT-S-05550-17 LVL by Stora Enso – Analysis of test results of X grade".
- [3] VTT Expert Services, "VTT-S-05710-17 LVL by Stora Enso –Analysis of test results of S grade".
- [4] Eurofins Expert Services Oy, "EUFI29-19002201-T1 - Flatwise loading tests of re-glued LVL beams GLVL-S and GLVL-X," 2019.
- [5] Eurofins Expert Services Oy, "Determination of flatwise bending and shear strength and stiffness properties of multiple glued Stora Enso GLVL-S and GLVL-X beams - Report no EUFI29-19002201-T2," 2019.
- [6] European Organisation for Technical Assessment EOTA, "European Assessment Document draft EAD DP 130337-00-0304," 2019.
- [7] VTT Expert Services, "LVL by Stora Enso - Determination of swelling and shrinkage values according to EN 318," VTT Expert Services, Espoo, 2018.
- [8] CEN European Committee for Standardization, EN 1995-1-1 - Eurocode 5: Design wo timber structures - Part 1-1: General - Common rules and rules for buildings, Brussels: CEN European Committee for Standardization, 2004.
- [9] Univ-Prof. Dr.Ing. H.J. Blaß, "Expert's Report/Evaluation Report Stora Enso Glued Laminated LVL," 19.07.2019.
- [10] Finnish Woodworking Industries, LVL Handbook EUROPE, 2020.
- [11] C. S. Hans Joachim Blaß, Timber Engineering - Principles for Design, KIT Scientific Publishing.
- [12] Austrian Standardization Institute, "ÖNORM EN 1995-1-1: Edition: 2006-01-01 (Identical with EN 1995-1-1:2004), Eurocode 5: Designof Timber Structures, Part 1-1: General – Common Rules and rules for buildings".
- [13] VTT Expert Services, "Certificate VTT-C-184/03: Kerto-S and Kerto-Q, Metsä Wood," Finland.
- [14] holz.bau forschungs gmbh, "Tests for the definition of the fracture energy G_I of LVL, Type S and FEM-analysis for the determination of the shear factor k_T for circular holes," Graz, Austria, July 2019.
- [15] holz.bau forschungs gmbh, "Tests on beams with circular and rectangular holes - Comparison of Design Methods," Graz, Austria, March 2019.
- [16] Austrian Standardization Institute, "ÖNORM B 1995-1-1:2015 "Eurocode 5: Design of Timber Structures, Part 1-1: General – Common Rules and rules for buildings. National specifications for the implementation of ÖNORM EN 1995-1-1, national comments and national supplements," Vienna, Austria.
- [17] holz.bau forschungs gmbh, "Tests for the definition of the fracture energy G of LVL, Type S and FEM-analysis for the determination of the shear factor k_T for circular holes," Graz, July 2019.
- [18] holz.bau forschungs gmbh, "Tests on beams with circular and rectangular holes - Comparison of Design Methods," Graz, March 2019.
- [19] Austrian Standardization Institute, "ÖNORM B 1995-1-1:2015 "Eurocode 5: Design of Timber Structures, Part 1-1: General – Common Rules and rules for buildings. National specifications for the implementation of ÖNORM EN 1995-1-1, national comments and national supplements", Vienna.
- [20] M. Ardalany, "Analysis and Design of Laminated Veneer Lumber Beams with Holes"Dissertation," Department of Civil and Natural Resources Engineering, University of Canterbury,Christchurch / New Zealand,, September 2012.
- [21] P. J. G. H. J. Larsen, "The Fracture Energy of Wood in Tension Perpendicular to the Grain – Results from a joint Testing Project, Proceedings CIB-Meeting Twenty Three, Paper CIB-W18A/23-19-2," Lisbon, 1990.
- [22] Austrian Standardization Institute, "ÖNORM EN1995-1-2 - Eurocode 5: Design of timber structures – Part 1– 2: General – Structural fire design, 2011-09-01 edition," 2011.
- [23] "EN 13501-1:2018 Fire classification of construction products and building elements.".
- [24] Eurofins Expert Services Oy, "Classification Report no EUFI29-19000344-T8- CLASSIFICATION OF REACTION TO FIRE IN ACCORDANCE WITH EN 13501-1:2018," 17 June 2019.



DESIGN MANUAL

Dec-20

- [25] Standardization, CEN European Committee for Standardization, EN 1995-1-2 - Eurocode 5: Design of timber structures - Part 1-2: General - Structural fire design, Brussels: CEN European Committee for Standardization, 2004.
- [26] P. H. & A. Richter, "BEMESSUNGS- UND KONSTRUKTIONSREGELN ZUM SCHWINGUNGSNACHWEIS VON HOLZDECKEN," Biberach, 2009.
- [27] CEN European Committee for Standardization, "EN 14080 - Timber structures - glued laminated timber and glued solid timber - requirements," CEN European Committee for Standardization, Brussels, 2013.
- [28] Eurofins Expert Services Oy, "Loading tests for re-glued LVL massive slab element - Report no EUFI29-19000150-T1," 2019.

